

Instruction Manual • June 2008



million
in one

sitrans

LR460

SIEMENS

Safety Guidelines: Warning notices must be observed to ensure personal safety as well as that of others, and to protect the product and the connected equipment. These warning notices are accompanied by a clarification of the level of caution to be observed.

Qualified Personnel: This device/system may only be set up and operated in conjunction with this manual. Qualified personnel are only authorized to install and operate this equipment in accordance with established safety practices and standards.

Unit Repair and Excluded Liability:

- The user is responsible for all changes and repairs made to the device by the user or the user's agent.
- All new components are to be provided by Siemens Milltronics Process Instruments Inc.
- Restrict repair to faulty components only.
- Do not reuse faulty components.

Warning: This product can only function properly and safely if it is correctly transported, stored, installed, set up, operated, and maintained.

This product is intended for use in industrial areas. Operation of this equipment in a residential area may cause interference to several frequency based communications.

Note: Always use product in accordance with specifications.

Copyright Siemens Milltronics Process Instruments Inc. 2008. All Rights Reserved	Disclaimer of Liability
This document is available in bound version and in electronic version. We encourage users to purchase authorized bound manuals, or to view electronic versions as designed and authored by Siemens Milltronics Process Instruments Inc. Siemens Milltronics Process Instruments Inc. will not be responsible for the contents of partial or whole reproductions of either bound or electronic versions.	While we have verified the contents of this manual for agreement with the instrumentation described, variations remain possible. Thus we cannot guarantee full agreement. The contents of this manual are regularly reviewed and corrections are included in subsequent editions. We welcome all suggestions for improvement. Technical data subject to change.

MILLTRONICS® is a registered trademark of Siemens Milltronics Process Instruments Inc.

Contact SMPI Technical Publications at the following address:

Technical Publications
Siemens Milltronics Process Instruments Inc.
1954 Technology Drive, P.O. Box 4225
Peterborough, Ontario, Canada, K9J 7B1
Email: techpubs.smpi@siemens.com

European Authorized Representative

Siemens AG
Industry Sector
76181 Karlsruhe
Deutschland

- For a selection of Siemens Milltronics level measurement manuals, go to: **www.siemens.com/processautomation**. Under Process Instrumentation, select *Level Measurement* and then go to the manual archive listed under the product family.
- For a selection of Siemens Milltronics weighing manuals, go to: **www.siemens.com/processautomation**. Under Weighing Technology, select *Continuous Weighing Systems* and then go to the manual archive listed under the product family.

Table of Contents

Safety Notes	1
Safety marking symbols	1
FCC and IC Conformity	2
The Manual	3
Technical Support	3
SITRANS LR460	6
Specifications	7
Power.....	7
Performance	7
Interface	8
Programmer (infrared keypad)	9
Mechanical.....	9
Environmental	10
Process.....	10
Communication.....	10
Approvals.....	11
Dimensions.....	12
Standard configuration	12
Installation	13
Mounting Location	13
Key considerations	14
Nozzle design	14
Nozzle location.....	15
Device orientation.....	15
Installation in vessel with obstructions	15
Easy Aimer Installation	16
Air Purging System (Optional)	17
Universal Slotted Flange (for use with Air Purging Option only)	18
Optional Dust Cap	19
Wiring	21
Connecting SITRANS LR460	21
HART wiring	22
PROFIBUS wiring	23
Hazardous area installations	25
Product Nameplate	25
Instructions specific to hazardous area installations	25
Quick Start	27
Activating SITRANS LR460	27
RUN mode display	27
Programming SITRANS LR460	28
The handheld programmer and PROGRAM mode display	28

Quick Start Wizard via the handheld programmer	29
Quick Start Wizard via SIMATIC PDM	31
Device Description (DD)	31
Quick Start Wizard steps	32
Level application example	36
Auto False Echo Suppression	36
Operating SITRANS LR460 via SIMATIC PDM	37
Functions in SIMATIC PDM	37
Features of SIMATIC PDM Rev. 6.0 SP3 (or higher)	37
Features of SIMATIC PDM Rev. 5.2 SP1	37
Echo profile saving and viewing	38
Trend Diagram (Level Trend over Time)	38
Manual TVT Shaper	39
Accessing Functions in PDM	40
Changing parameter settings via SIMATIC PDM	41
Configuring a new device	41
Calibrating LR460 via PDM	41
Parameters accessed via pull-down menus	41
Reset	41
Configuration Flag Reset (HART only)	42
Auto False Echo Suppression	42
D/A (Digital/Analog) Trim (HART only)	42
Simulate AO (Analog Output) (HART only)	42
Simulation	42
Parameter Reference	45
Parameter menus	45
Pull-down menus for HART via SIMATIC PDM	45
Pull-down menus for PROFIBUS PA via SIMATIC PDM	46
Quick Start Wizard	47
Quick Start	47
Identification (IDENT)	49
Input	55
Output	68
Condensed Status Setup (COND SETUP) (PROFIBUS PA only)	88
Appendix A: Technical Reference	91
Principles of Operation	91
Measurement Response	91
Echo Processing	92
Profile monitoring via SIMATIC PDM	92
Time Varying Threshold (TVT)	92
Echo selection	92
False Echoes	93
Auto False-Echo Suppression	93
Near Range (Blanking)	94
Echo confidence	94
Loss of Echo (LOE)	94
LOE Timer	94

Fail-safe Mode	94
Maximum Process Temperature Chart	96
Appendix B: Troubleshooting	99
General Fault Codes	102
Appendix C: Maintenance	105
Unit Repair and Excluded Liability	105
Appendix D: Local Operation Interface	107
The LCD Display	107
RUN mode (startup display)	107
PROGRAM Mode Display	107
The handheld programmer	108
Hand-held programmer: key functions in RUN mode	108
PROGRAMMING via the handheld programmer	108
Hand-held programmer: key functions in Navigation mode	109
Hand-held programmer: key functions in Edit mode	109
Individual Parameter Reset	109
Appendix E: HART Communications	111
HART Device Description (DD)	111
SIMATIC Process Device Manager (PDM)	111
HART modem interface for SIMATIC PDM	111
HART Version	112
HART Burst Mode	112
HART Communication Parameter	112
HART Communicator 375 Menu Structure	113
Appendix F: HART Information Structure	117
Block Model for recording and processing measured values	117
Description of the blocks	118
Appendix G: Communications via PROFIBUS PA	119
Device Configuration tool	119
SIMATIC PDM	119
Device Description	119
Network Configuration	119
The GSD file	119
Bus Termination	119
Power Demands	120
PROFIBUS address	120
Operating as a Profile Device	120
Configuring a new device: procedure	121
Configuring PROFIBUS PA with an S7-300/ 400 PLC	121
Cyclic versus Acyclic Data	121
Cyclic Data	121
Status Byte	122
Condensed Status	124

Diagnostics	126
Diagnosis reply (applies only to cyclic masters)	126
Acyclic Diagnostics	126
Extended Mode Diagnosis	127
Condensed Mode Diagnosis	128
Acyclic Extended Diagnostics (General Fault Codes)	128
Acyclic Data	129
Appendix H: PROFIBUS PA Profile Structure	131
PROFIBUS Level Device Design	131
Block Model for recording and processing measured values	131
Description of the blocks	132
Level Transducer Block function groups	132
Analog Input Function Blocks 1 and 2.....	134
Appendix J: Software Revision History	137
PROFIBUS PA	137
HART	137
Glossary	139
Index	143
LCD Menu Structure	145

Safety Notes

Special attention must be paid to warnings and notes highlighted from the rest of the text by grey boxes.



WARNING: relates to a caution symbol on the product, and means that failure to observe the necessary precautions can result in death, serious injury, and/or considerable material damage.



WARNING: means that failure to observe the necessary precautions can result in death, serious injury, and/or considerable material damage.

Note: means important information about the product or that part of the operating manual.

Safety marking symbols

In manual:	On product:	Description
		Earth (ground) Terminal
		Protective Conductor Terminal
		Alternating Current
		Direct Current
		(Label on product: yellow background.) WARNING: refer to accompanying documents (manual) for details.

FCC and IC Conformity

US Installations only: Federal Communications Commission (FCC) rules

! WARNING: Changes or modifications not expressly approved by Siemens Milltronics could void the user's authority to operate the equipment.

Notes:

- This equipment has been tested and found to comply with the limits for a Class A digital device, pursuant to Part 15 of the FCC Rules. These limits are designed to provide reasonable protection against harmful interference when the equipment is operated in a commercial environment.
- This equipment generates, uses, and can radiate radio frequency energy and, if not installed and used in accordance with the instruction manual, may cause harmful interference to radio communications. Operation of this equipment in a residential area is likely to cause harmful interference to radio communications, in which case the user will be required to correct the interference at his own expense.

Canadian Installations only: Industry Canada (IC) rules

Notes:

- This device shall be installed and operated in a completely enclosed container to prevent RF emission, which otherwise can interfere with aeronautical navigation. Installation shall be done by trained installers, in strict compliance with the manufacturer's instructions.
- The use of this device is on a 'no-protection non-interference' basis.
 - The user shall accept operations of high powered radar in the same frequency band, which may interfere with or damage this device.
 - The user is responsible for removing, at the user's expense, any device found to interfere with primary licensing operations.

The Manual

Notes:

- Please follow the installation and operating procedures for a quick, trouble-free installation and to ensure the maximum accuracy and reliability of your SITRANS LR460.
- This manual applies to the SITRANS LR460 only.
- This product is intended for use in industrial areas. Operation of this equipment in a residential area may cause interference to several frequency based communications.

This manual will help you set up your SITRANS LR460 for optimum performance. We always welcome suggestions and comments about manual content, design, and accessibility. Please direct your comments to techpubs.smpi@siemens.com.

For other Siemens Milltronics level measurement manuals, go to: www.siemens.com/level, and click on **Instructions and Manuals** in the **More Info** list.

Application Examples

The application example used in this manual illustrates a typical installation using SITRANS LR460. There is often more than one way to approach an application, and other configurations may also apply. If the example does not apply to your application, check the applicable parameter reference for the available options.

Technical Support

Support is available 24 hours a day.

To find your local Siemens Automation Office address, phone or fax number go to: www.siemens.com/automation/partner

- Click on the tab **Contacts by Product** and then find your product group (**+Process Automation > +Process Instrumentation > +Level Measuring Instruments**).
- Select the team **Technical Support**. Click on **Next**.
- Click on the appropriate continent, then select the country followed by the city. Click on **Next**.

For on-line technical support go to:

www.siemens.com/automation/support-request

- Enter the device name (SITRANS LR460) or order number, then click on **Search**, and select the appropriate product type. Click on **Next**.
- You will be prompted to enter a keyword describing your issue. Then either browse the relevant documentation, or click on **Next** to email a detailed description of your issue to Siemens Technical Support staff.

Siemens A&D Technical Support Center: phone +49 180 50 50 222
fax +49 180 50 50 223+

Abbreviations and Identifications

Short form	Long Form	Description	Units
A/D	Analog to digital		
AIFB	Analog Input Function Block		
CE / FM / CSA	Conformité Européene / Factory Mutual / Canadian Standards Association	safety approval	
C_i	Internal capacitance		Farad
D/A	Digital to analog		
DAC	Digital Analog Converter		
DCS	Distributed Control System	control room apparatus	
FV	Full Vacuum		
ESD	Electrostatic Discharge		
HART PV	HART Primary Variable	Output value from AIFB1	
HART SV	HART Secondary Variable	Output value from AIFB2	
I_i	Input current		mA
I_o	Output current		mA
IS	Intrinsically Safe	safety approval	
L_i	Internal inductance		mH
LR	Level Radar		
LTB	Level Transducer Block		
mH	milliHenry	10^{-3}	Henry
μ F	microFarad	10^{-6}	Farad
μ s	microsecond	10^{-6}	Second
PA	Process Automation (PROFIBUS)		
PDM	Process Device Manager (SIMATIC)		
pF	pico Farads	10^{-12}	Farad
ppm	parts per million		
psia	pounds/square inch absolute		
PV	Primary Value ¹	default measured value	
RH	relative humidity		
SCFM	standard cubic feet/minute		
SV1	Secondary Value1 ¹	LTB level output (level units)	
SV2	Secondary Value2 ¹	LTB distance output (sensor units)	

Short form	Long Form	Description	Units (cont'd)
TV	Transmitter Variable		
TVT	Time Varying Threshold	sensitivity threshold	
U_i	Input voltage		V
U_o	Output voltage		V

1. The output from the Level Transducer Block can be called the Primary Value (or Secondary Value). When it becomes the input to the AIFB, it is called the Process Variable. It is distinct from the HART PV.

SITRANS LR460

SITRANS LR460 is a 4-wire, 24 GHz FMCW (Frequency Modulated/Continuous Wave) radar level transmitter for continuous monitoring of solids in silos to a range of 100 meters (329 ft). It is ideal for applications with extreme dust and high temperatures to +200 °C (+392 °F). The Easy Aimer design makes it easy to install the device and orient the signal towards the material angle of repose. The high frequency signal creates a narrow emission cone, which makes the LR460 quite insensitive to vessel interferences.

SITRANS LR460

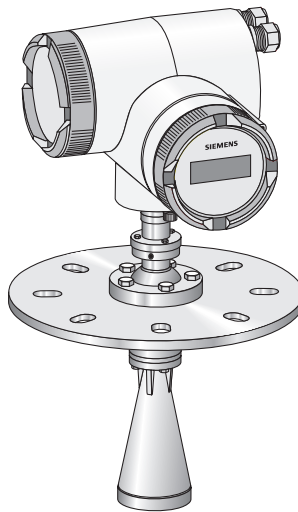

SITRANS LR460 is available with an optional air purge connection for cleaning the interior of the antenna.

Programming

SITRANS LR460 carries out its level measurement function according to the set of built-in parameter tables. You can make parameter changes via the Siemens Milltronics handheld programmer, a PC running SIMATIC PDM or other similar software packages.

Approvals and Certificates

SITRANS LR460 is available with General Purpose approval, or approval for hazardous areas containing dust. For details see *Approvals* on page 11.

System Implementation

SITRANS LR460 supports HART communication protocol, or PROFIBUS PA (optional), and SIMATIC PDM software.

Specifications

Note: Siemens Milltronics makes every attempt to ensure the accuracy of these specifications, but reserves the right to change them at any time.

SITRANS LR460

Power

Power Supply

- 100 to 230 V AC, $\pm 15\%$, 50/60 Hz, 6 W
- 24 V DC, +25/-20%, 6 W
- Fuse (AC)

SI1	Fast acting ceramic, 4 x 20 mm, 1 A, 250 V AC
SI2	Slow-Blow, 4 x 20 mm, 0.63 A, 250 V AC
- Fuse (DC)

SI1	Fast acting ceramic, 4 x 20 mm, 2 A, 250 V AC
SI2	Slow-Blow, 4 x 20 mm, 0.63 A, 250 V AC

Performance

Reference operating conditions according to IEC 60770-1

- ambient temperature +15 to +25 °C
- humidity 45 to 75% relative humidity
- ambient pressure 860 to 1060 mbar (12.47 to 15.37 psi)

Measurement Accuracy (measured in accordance with IEC 60770-1)

- non-linearity (accuracy) greater of 25 mm (1") or 0.25% of span (including hysteresis and non-repeatability)
- non-repeatability 10 mm (0.4") [included in non-linearity specification]
- deadband (resolution) 10 mm (0.4") [included in non-linearity specification]
- hysteresis error 0 mm

Analog Output Accuracy (measured in accordance with IEC 60770-1)

- non-linearity (accuracy) 0.100% of span (including hysteresis and repeatability)
- non-repeatability 0.030% of span (included in non-linearity specification)
- deadband (resolution) 0.030% of span [included in non-linearity specification]
- hysteresis error 0%

Frequency 25 GHz nominal

Measurement range¹ 0.35 to 100 m (1.15 to 328.08 ft)

¹ Referenced from flange face.

Long-term stability	$\leq \pm 1$ mm/year
Near Range (blinking)	0.35 m (1.15 ft)
Update time	mA output and loop display is updated once per second
Beam angle	
• 3" horn:	11° at -3 dB boundary
• 4" horn:	8° at -3 dB boundary
Memory	
• non-volatile EEPROM	
• no battery required	

Interface

Analog output (Not applicable to PROFIBUS PA option)	
• signal range	4 to 20 mA upper limit 20 to 22.6 mA adjustable
• fail signal	3.6 mA to 22.6 mA; or last value
• load	Max. 600 Ω ; for HART ¹ communication min. 230 Ω
Digital output (Not applicable to PROFIBUS PA option)	
• function	Configurable as a device status or limit value (level)
• signal type	Relay, either NCC or NOC function, max. 50 V DC, max. 200 mA, rating max. 5 W Self-resetting fuse, $R_f = 9 \Omega$
Electrical isolation	Outputs electrically isolated from the power supply and from each other
Display	
• LCD	two lines of 16 characters each, configurable for the following displays: level, amplitude, digital output, temperature, validity, signal-to-noise ratio, output current, distance

¹. HART[®] is a registered trademark of HART Communication Foundation.

Programmer (infrared keypad)¹

Siemens Milltronics infrared IS (Intrinsically Safe) handheld programmer for hazardous and all other locations (battery is non-replaceable)

- approval: ATEX II 1 G EEx ia IIC T4, certificate SIRA 01ATEX2147 CSA and FM Class I, Div. 1, Gr. A, B, C, D T6 @ max. ambient temperature of +40 °C (+104 °F)
- ambient temperature: –20 to +40 °C (–5 to +104 °F)
- interface: proprietary infrared pulse signal
- power: 3 V lithium battery
- weight: 150 g (0.3 lb)
- color: black

Mechanical

Wetted parts (in contact with the process)

- flange and horn 304 stainless steel (or equivalent)
- emitter PTFE

Process Connection

- universal flanges 3"/80 mm, 4"/100 mm, 6"/150 mm (See page 18 for flange dimensions.)

Pressure (vessel)

0.5 bar (7.25 psi) maximum

Horn

- 3" horn 2.93" (74.5 mm) diameter
- 4" horn 3.84" (97.5 mm) diameter

Weight

- Weight of instrument and flange

Process Connection	Weight
Universal, 3" / 80 mm flange with 3" horn	6.1 kg (13.4 lbs)
Universal, 4" / 100 mm flange with 4" horn	10.6 kg (23.36 lbs)
Universal, 6" / 160 mm flange with 4"horn	11.8 kg (26 lbs)

¹. Ordered separately.

Enclosure

- construction
- conduit

- ingress protection

Die-cast aluminum, painted (polyester powder-coated)
2 x M20
or 2 x ½" NPT (option)
Type 4X/NEMA 4X, Type 6/NEMA 6, IP67¹

Dust cap (optional)

- 3"
- 4"

PTFE, pipe clamp connection, O.D. 95 mm (3.74")
PTFE, pipe clamp connection, O.D. 120 mm (4.72")

Air Purge Connection

- equipped with female 1/8" NPT fitting

Environmental

- location
- altitude
- relative humidity
- installation category
- pollution degree
- permitted ambient

indoor/outdoor
2000 m (6562 ft) max
suitable for outdoor (Type / NEMA 4X, 6/ IP67)
II
4
-40 to +65 °C (-40 to +149 °F) (non-hazardous version)
temperature²LCD: -10 to +55 °C (+14 to +131 °F)
Observe the temperature classes in hazardous areas!

Process

- Process temperature³
- Pressure (vessel)

-40 to +200 °C (-40 to +392 °F)
0.5 bar (7.25 psi) maximum

Communication

Communication: HART

- Load

- Max. Line Length
- Protocol

230 to 600 Ω, 230 to 500 Ω when connecting a coupling module
multi-wire: ≤ 1500 m (4921 ft)
HART, Version 5.1

¹ Use only approved, suitable sized hubs for watertight applications.

² Operating temperature of LCD display.

³ Process temperature varies with ambient temperature. See Process/Ambient de-rating curves on page 96 of Appendix A.

Communication: PROFIBUS PA

- Protocol PROFIBUS PA,
technology: IEC 61158-2, slave-functionality
- Device Profile 3.01
- Device Class B

Bus current (PROFIBUS PA) 10.5 mA

Approvals

- Hazardous areas FM/CSA Class II, Div. 1, Groups E,F and G, Class III
ATEX II 1 D; 1/2 D, 2D T85 deg C
INMETRO BR-Ex tD A20 T85 deg C IP67
- General CSAus/c, FM, CE, C-TICK
- Radio FCC, Industry Canada, European Radio (R&TTE),
C-TICK

Dimensions

Standard configuration

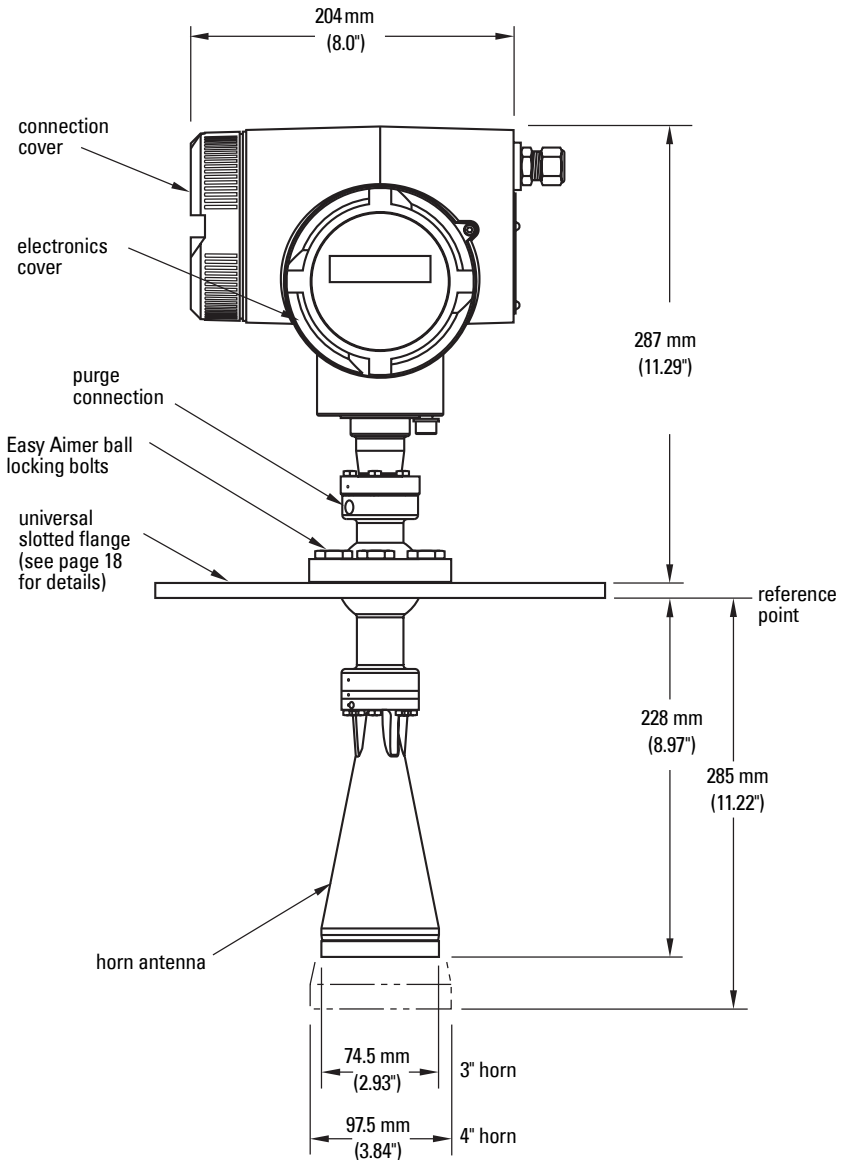

Specifications

Installation



WARNINGS:

- **SITRANS LR460 is to be used only in the manner outlined in this manual, otherwise protection provided by the equipment may be impaired.**
- **Installation shall only be performed by qualified personnel and in accordance with local governing regulations.**

Notes:

- For European Union and member countries, installation must be according to ETSI EN 302372.
- Refer to device nameplate for approval information.
- Use appropriate conduit and conduit fittings or cable glands, to maintain IP or NEMA rating.
- Observe all maximum permissible ambient and process temperatures. Refer to *Maximum Process Temperature Chart* on page 96.
- For US and Canadian installations, see *FCC and IC Conformity* on page 2.

Mounting Location

Notes:

- Provide easy access for viewing the display and programming via the handheld programmer.
- Provide an environment suitable to the housing rating and materials of construction.
- Provide a sun shield if the device is mounted in direct sunlight.

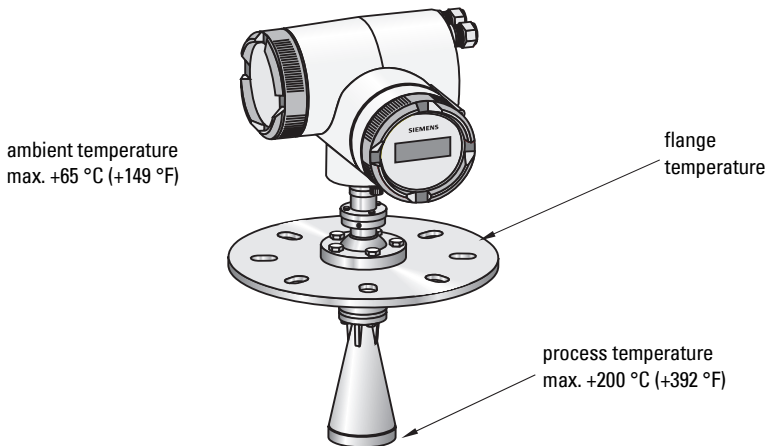

Key considerations

- Correct location is critical to a successful application.
- Avoid reflective interference from vessel walls and obstructions by following the guidelines below.



! WARNINGS:

- **Do not remove factory lock screw.**
- **Do not rotate upper wave guide with respect to housing or internal change may occur.**

Nozzle design

- Bottom edge of horn must project from nozzle.
- Nozzle must allow adequate clearance to allow positioning if LR460 has to be at an angle so that emission cone perpendicular to material surface.

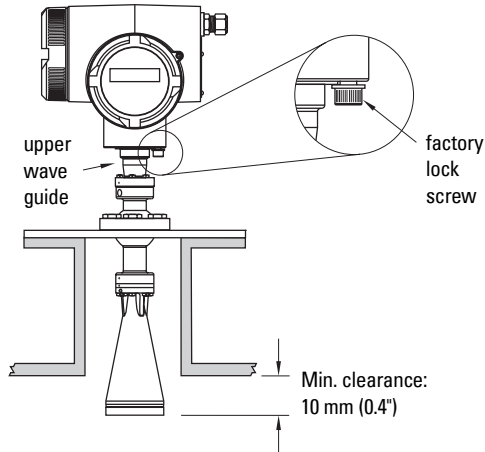

Nozzle location

- Locate antenna at least 1 meter away from side wall.
- Keep emission cone free of interference from ladders, pipes, I-beams or filling streams.
- Make allowance for beam spread to avoid interference with the emission cone.

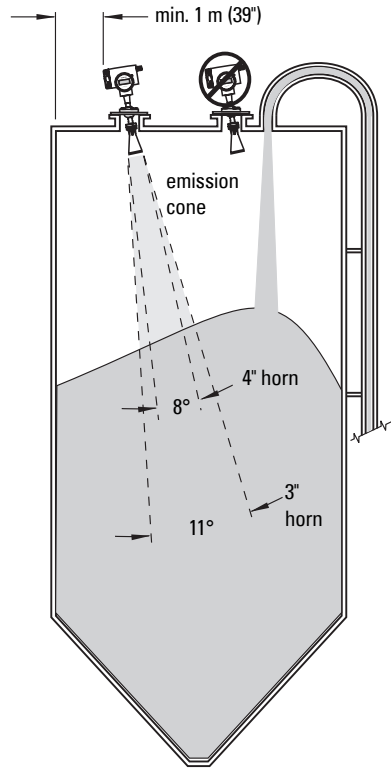

Device orientation

- Align the antenna so that the radar cone is perpendicular to the surface of the monitored material, if possible. (See *Easy Aimer Installation* on page 16.)
- To compensate for vessels with obstructions, see also *Polarization Reference Point* on page 15.

Installation in vessel with obstructions

Polarization Reference Point

Obstructions such as ladders, pipes, or the fill path, can cause false reflections. To avoid this, use the Polarization Reference Point to orient the device.

- A small center punch mark provides a polarization reference point.
- To get the best signal, loosen the Easy Aimer ball locking bolts and rotate the device until the Polarization Reference Point either faces towards the obstruction, or faces away from the obstruction (at 180 degrees). Tighten ball locking bolts when unit is in desired position.

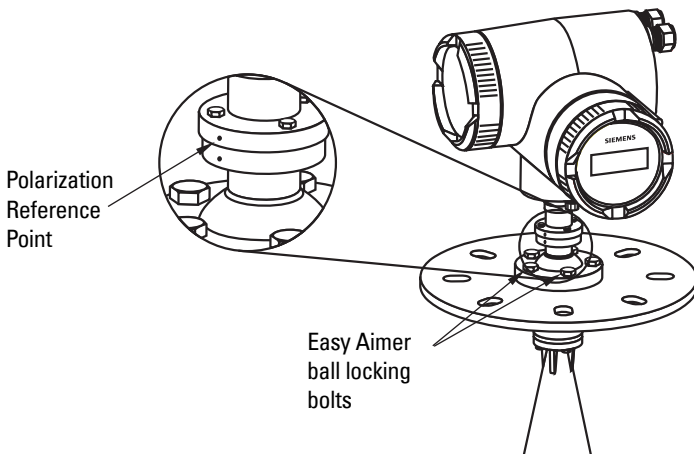

Easy Aimer Installation

Note: When the Easy Aimer ball is loosened, the device is free to tilt to a maximum of 30°.

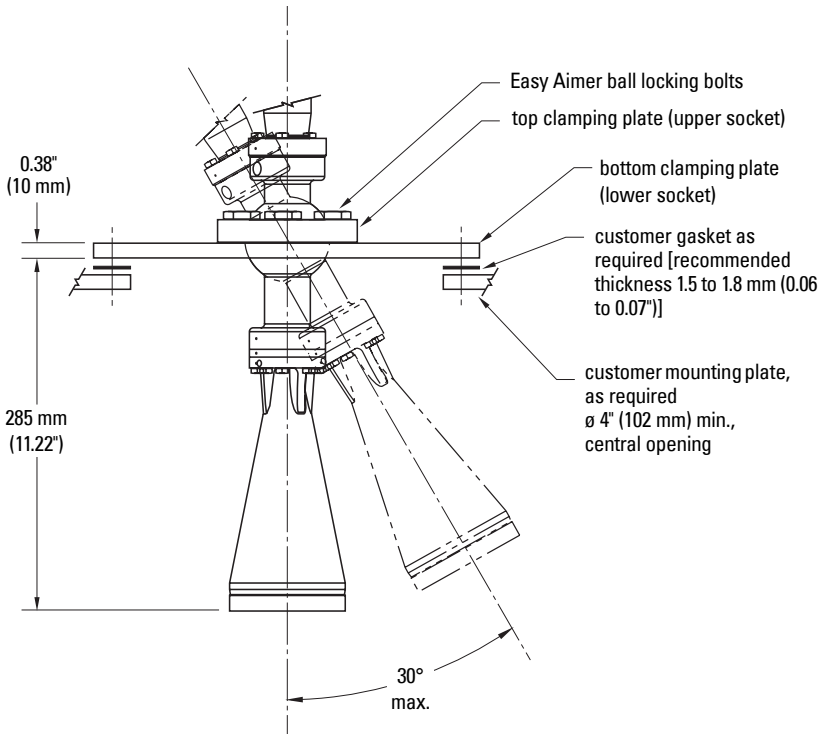

1. Holding the electronics enclosure firmly, loosen the Easy Aimer ball locking bolts and gently reposition the enclosure.
2. Direct SITRANS LR460 so the horn antenna is pointed at an angle perpendicular to the material surface, if possible. (As a guide, aim the beam at a point approximately 2/3 of the way across the tank diameter.)
3. When the desired position is reached, retighten the 5 bolts to 15-23 N m (11 to 17 Lbf-ft).

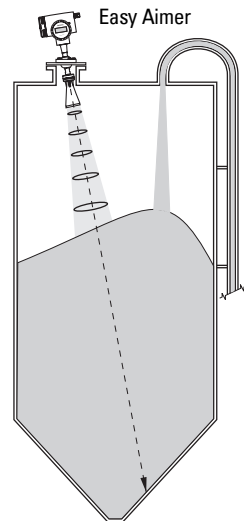

Air Purging System (Optional)

For more frequent cleaning, a purging system can be installed between the flange and the horn antenna. The system provides an 1/8" inlet (female thread) on the flange where cooling air or cleaning fluid passes through the flange and exits the inside of the horn to clean it. The customer will supply the purging medium by a manual or automatic valve system.

This option is only available with the universal flange for purging shown on page 18.

Notes:

- The Air Purge feature should not be activated with a dust cap in place.
- Purge duration, pressure, and interval, will vary with each application. It is the user's responsibility to determine the requirements depending on the application and cleaning required.
- Short duration bursts of high pressure provide more effective cleaning than continuous low pressure air.
- Some dust particles are highly abrasive and can be drawn into the inside of the horn during purge cleaning, damaging the internal PTFE emitter of the antenna. A replacement kit is available from your local Siemens Milltronics representative.
- It is the customer's responsibility to ensure that any vacuum or pressure in the measured vessel is maintained, considering the hole that passes through the process connection and SITRANS LR460 antenna system.

Recommendation for effective cleaning	Air Consumption (Flow rate versus applied pressure)	
	Air Pressure	Approx. inlet volume flow rate
Pressure: 90 to 110 psi	20	5 SCFM
	40	6 SCFM
	60	8 SCFM
Inlet flow: 10 SCFM ¹	80	9 SCFM
	90	10 SCFM

- The purge connection is closed by the manufacturer, using a 1/8" plug.
- When the plug is removed to connect a purging system, the operator is responsible for ensuring that the purging circuit conforms to "Ex" requirements: for example, by fitting an NRV valve.

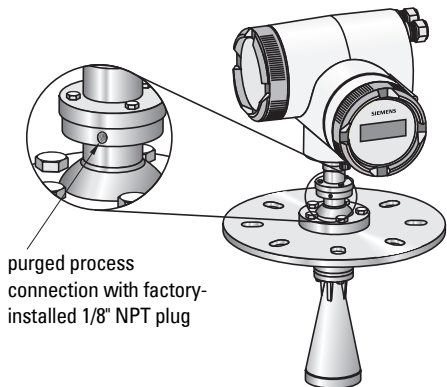

¹. SCFM (standard cubic feet/minute) referenced to 14.7 psia, 68°F and 36% relative humidity (RH).

Universal Slotted Flange (for use with Air Purging Option only)

! WARNING: The user is responsible for the selection of bolting and gasket materials which will fall within the limits of the flange and its intended use and which are suitable for the service conditions.

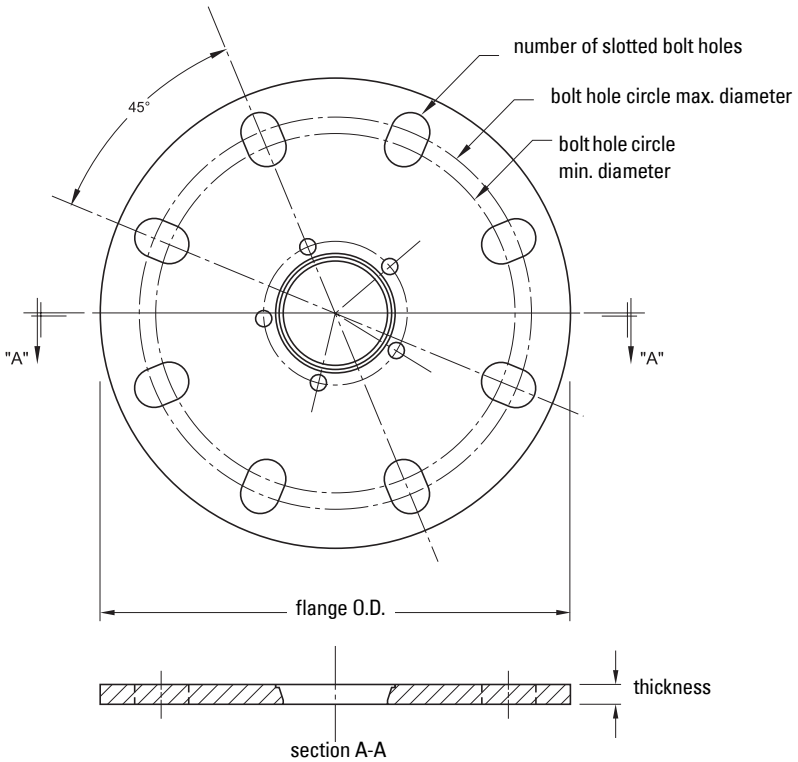

Slotted Flange Dimensions (see above)¹

Pipe Size	Flange O.D.	Thick-ness (s)	Bolt Hole Circle Max Ø	Bolt Hole Circle Min Ø	Bolt Hole radius	No. of Slotted Holes
3" or 80 mm	7.87" (200 mm)	0.38" (9.65 mm)	6.30" (160 mm)	5.91" (150 mm)	0.38" (9.5 mm)	8
4" or 100 mm	9.00" (229 mm)	0.38" (9.65 mm)	7.52" (191 mm)	6.89" (175 mm)	0.38" (9.5 mm)	8
6" or 150 mm	11.22" (285 mm)	0.38" (9.65 mm)	9.53" (242 mm)	9.45" (240 mm)	0.45" (11.5 mm)	8

¹ Universal flange mates with EN 1092-1 / ASME B16.5 / JIS B2238 bolt hole pattern.

Optional Dust Cap

Note: The dust cap must be removed before using the Air Purge feature (see *Air Purging System (Optional)* on page 17).

The dust cap fits onto the end of the horn and prevents the buildup of dust and other process material inside the horn.

- It is particularly useful for applications in areas of high humidity, or with bulk solids with a high moisture content.
- Two sizes are available, to fit the standard 3" and 4" horns.

Installation

1. Thoroughly clean inside the horn. If you remove the horn for easier cleaning, take care not to damage or bend the plastic emitter.

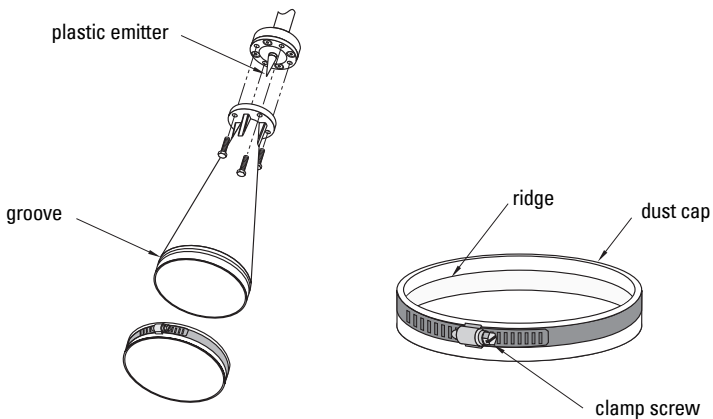

2. Press the cap firmly onto the horn until the ridge inside the cap snaps into position in the groove on the outside of the horn.
3. Hand tighten the adjustable clamp supplied to secure the cap.
4. Use a screwdriver or nut driver to tighten the clamp screw until the clamp provides an air-tight seal.

Note: It is critical to ensure no moisture can be trapped inside.

Notes:



WARNINGS:

- Turn off power to the device before unscrewing the housing cover in a hazardous area.
- All field wiring for AC models must have insulation suitable for at least 250 V.
- The DC input terminals shall be supplied from a source that provides electrical isolation between the input and the output, in order to meet the applicable safety requirements of IEC 61010-1.
- The equipment shall be protected by a fuse or circuit breaker of up to 16 A in the building installation.
- A circuit breaker or switch in the building installation, marked as the disconnect switch, shall be in close proximity to the equipment and within easy reach of the operator.
- To avoid short-circuits, do not connect a load resistance with bare wires inside the connection box.

Notes:

- AC and DC input circuits: min. 14 AWG (2.5 sq. mm) copper wire.
- Lay power cables separately from communication wiring.
- Recommended torque on terminal clamping screws: 0.5 to 0.6 N m (0.37 to 0.44 Lbf-ft).

Connecting SITRANS LR460

1. Release the cover lock on the enclosure with a 3 mm Allen key and unscrew the cover. (Use a screwdriver for extra leverage, if required.)
2. Loosen the cable gland and push the power cable through until it reaches the terminal strip.

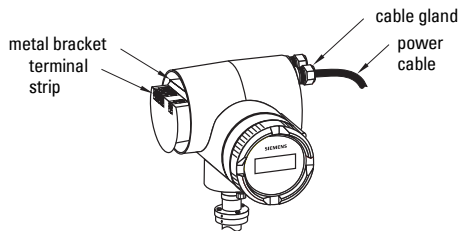
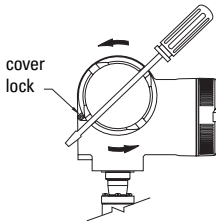

(Go to *HART wiring* on page 22 or *PROFIBUS wiring* on page 23 for next steps.)

HART wiring

Note: LR460 HART requires no power from the 4-20 mA loop.

AC version

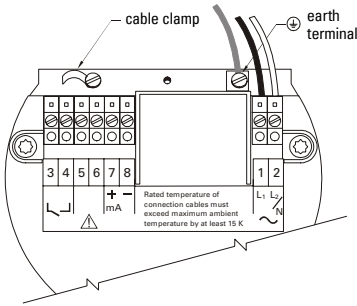

DC version

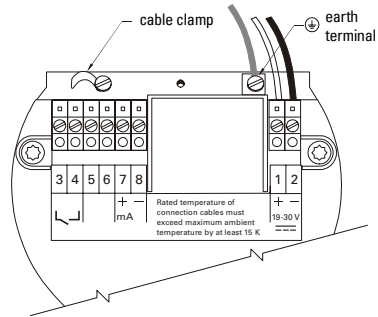

Connecting HART

Typical PLC/mA configuration with HART

Notes:

- For error-free communication via the HART protocol, a 250 Ohm resistor may be required if the loop resistance is less than 250 Ohms.
- Only one HART communication device should be inserted in the loop.

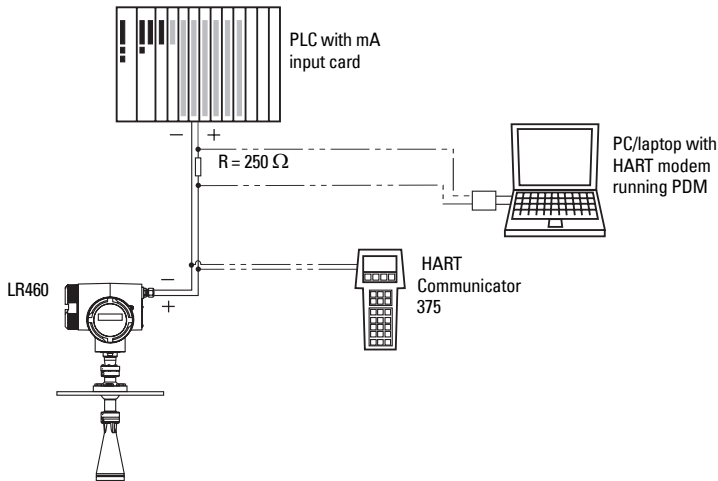

(Continued from *Connecting SITRANS LR460* on page 21, step 2.)

3. Connect the earth conductor of the power supply to the earth terminal (⊕) on the metal bracket inside the enclosure. Adjust the cable length so that the earth conductor would be last to disconnect if cable is pulled.

4. Tighten the cable gland and check the strain relief (pull and turn).
5. Replace the enclosure cover and hand tighten it. The sealing ring must be clean and undamaged.
6. Tighten the screw on the cover lock.
7. Connect the external earth terminal located between the cable glands to a ground connection at your vessel. Use a cable with a cross-section of 2.5 mm² or greater.

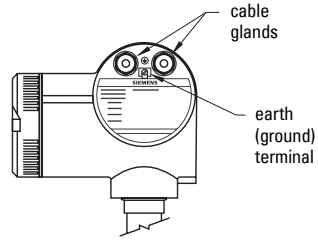

Full details about HART can be obtained from the HART Communication Foundation at <http://www.hartcomm2.org>.

PROFIBUS wiring

Note: PROFIBUS PA in this device is not polarity-sensitive.

Power Demands

To determine how many devices can be connected to a bus line, calculate the combined maximum current consumption of all the connected devices: 10.5 mA for SITRANS LR 460. Allow a current reserve for safety.

Bus Termination

PROFIBUS PA **MUST** be terminated at both extreme ends of the cable for it to work properly. Please refer to the PROFIBUS PA User and Installation Guidelines (order number 2.092), available from www.profibus.com.

Install in accordance with *PROFIBUS PA User and Installation Guidelines* (order number 2.092), available from www.profibus.com.

AC version

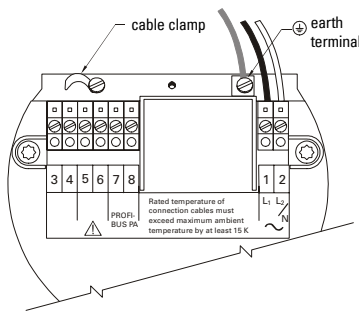

DC version

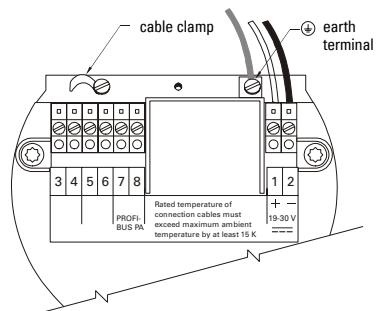

Connecting PROFIBUS PA

Typical PLC/mA configuration with PROFIBUS PA

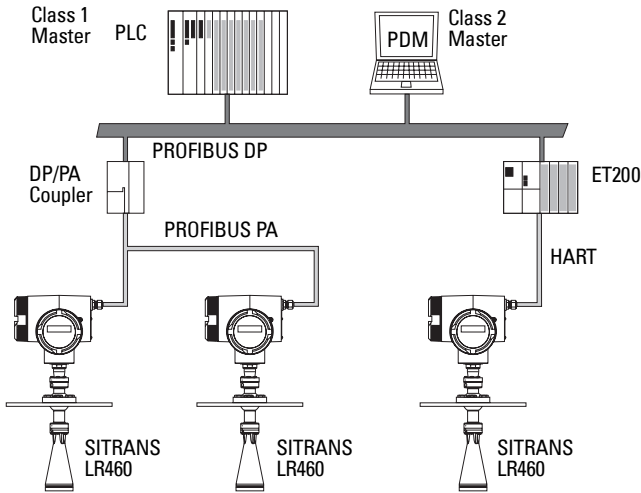

(Continued from *Connecting SITRANS LR460* on page 21, step 2.)

3. Connect the earth conductor of the power supply to the earth terminal (⊕) on the metal bracket inside the enclosure. Adjust the cable length so that the earth conductor would be last to disconnect if cable is pulled.
4. Tighten the cable gland and check the strain relief (pull and turn).
5. Replace the enclosure cover and hand tighten it. The sealing ring must be clean and undamaged.
6. Tighten the screw on the cover lock.
7. Connect the external earth terminal located between the cable glands to a ground connection at your vessel. Use a cable with a cross-section of 2.5 mm² or greater.

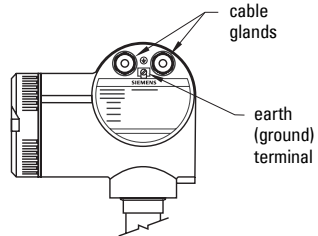

Hazardous area installations

Product Nameplate

Note: The nameplate shown is a typical example. Please check the nameplate on your device for your specific device configuration.

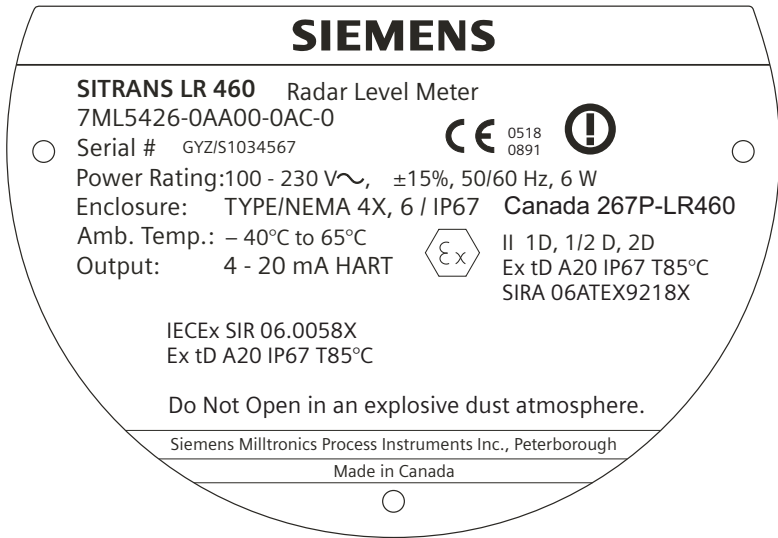

Instructions specific to hazardous area installations

(Reference European ATEX Directive 94/9/EC, Annex II, 1/0/6)

Note: Installation shall be performed only by qualified personnel and in accordance with local governing regulations.

The following instructions apply to equipment covered by certificate number Sira 06 ATEX 9218X.

1. For use and assembly, refer to the main instructions.
2. The equipment is certified for use as Category II 1D, 1/2 D & 2D equipment. The Essential Health and Safety Requirements are assured by compliance with IEC 61241-0: 2004 and IEC 61241-1: 2004.
3. The equipment may be used with dust and fibers with apparatus temperature class T (see table *Thermal Data for 7ML5426 Series* on page 26).

4. Thermal Data for 7ML5426 Series

Device category	Permitted ambient temperature at horn antenna	Permitted ambient temperature at electronic enclosure
1D, 1/2D, 2D	$-40\text{ }^{\circ}\text{C} (-40\text{ }^{\circ}\text{F}) \leq T_{\text{amb}} \leq +200\text{ }^{\circ}\text{C}$ (+392 °F)	$-40\text{ }^{\circ}\text{C} (-40\text{ }^{\circ}\text{F}) \leq T_{\text{amb}} \leq +65\text{ }^{\circ}\text{C}$ (+149 °F)

5. The equipment has not been assessed as a safety related device (as referred to by Directive 94/9/EC Annex II, clause 1.5).
6. Installation and inspection of this equipment shall be carried out by suitably trained personnel in accordance with the applicable code of practice (EN 61241-14 and EN 61241 –17 in Europe).
7. Repair of this equipment shall be carried out by suitably trained personnel in accordance with the applicable code of practice.
8. Components to be incorporated into or used as replacements in the equipment shall be fitted by suitably trained personnel in accordance with the manufacturer's documentation.
9. It is the user's responsibility to ensure that a manual override is possible in order to shut down the equipment, and that protective systems are incorporated within automatic processes which deviate from the intended operating conditions, provided that this does not compromise safety.
10. Equipment Marking: The equipment marking contains at least the information on the product label. See *Product Nameplate* on page 25.
11. If the equipment is likely to come into contact with aggressive substances, it is the user's responsibility to take suitable precautions to prevent it from being adversely affected, and to ensure that the type of protection is not compromised.
 - Aggressive substances include, for example, acidic liquids or gases that may attack metals, or solvents that may affect polymeric materials.
 - Suitable precautions include, for example, regular checks as part of routine inspections, or establishing from the material's data sheet that it is resistant to specific chemicals.

SPECIAL CONDITIONS FOR SAFE USE

The 'X' suffix to the certificate number relates to the following special condition(s) for safe use.

- Cable or conduit entries must meet the requirements of European Directive 94/9/EC for Group II, Category 1D, 1/2D, or 2D, as appropriate, and must maintain the overall IP rating of the enclosure.
- For applications that require the purge feature, the user shall implement a means to ensure that combustible dust from the hazardous area cannot enter the purge supply in such a way as to compromise the area classification.

Note: SITRANS LR460 only supports SIMATIC PDM version 6.0 SP3 (or higher).

To set up SITRANS LR460 for a simple application requires only the following settings:

- select application type (silo construction)
- select operation mode: level, distance or space
- set speed of response
- set High and Low Calibration Points

A Quick Start wizard groups together all the settings you need. There are two ways to access the wizard:

- *Quick Start Wizard via the handheld programmer* on page 29
- *Quick Start Wizard via SIMATIC PDM* on page 31

Note: When using the Quick Start Wizard, the value for parameter 3.5.2.6 changes. This can affect the distance measurement reading. See parameter section *Position Detect (E POS)* on page 61.

Activating SITRANS LR460

Notes:

- Keep infrared devices such as laptops, cell phones, and PDAs, away from SITRANS LR460 to prevent inadvertent operation.
- Frequently switching the device off and on causes wear of the electronics (see 2.3 *Statistics (STATS)* on page 55 to access the records).

Power up the instrument. SITRANS LR460 automatically starts up in **RUN** mode, and detects the distance to the material level referenced from the sensor flange face. The LCD displays the measurement and the default unit is meters. System status is displayed on the LCD, or on a remote communications terminal.

RUN mode display

Normal operation

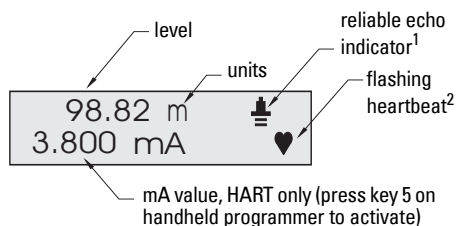

LOE condition

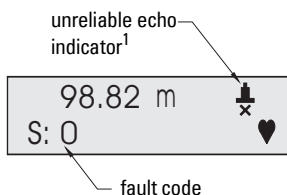

See *RUN mode (startup display)* on page 107 for more detailed information.

¹ See *Loss of Echo (LOE)* on page 94 for more detail.

² Flashes once per second to indicate that the device is functioning.

Programming SITRANS LR460

Activate **PROGRAM** mode at any time, to change parameter values and set operating conditions.

- Parameters are organized into function groups and arranged in a four-level menu structure (see *LCD Menu Structure* on page 145).
- Set parameters to suit your specific application.
- For a detailed list with instructions, see *Parameter Reference* on page 45.

The handheld programmer and PROGRAM mode display

Note: See *Appendix D: Local Operation Interface* on page 107 for more detailed information on the programmer and the LCD display.

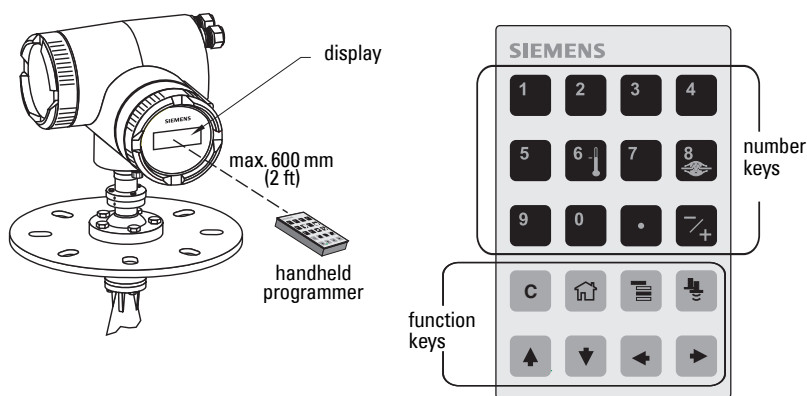

- Point the programmer at the display (from a maximum distance of 600 mm [2 ft.]) and press **Mode** to activate PROGRAM mode.
- Use **ARROW keys** to navigate to a menu item. (See *LCD Menu Structure* on page 145.)
- Press **Right ARROW** to open Edit mode: the PROGRAM icon will flash.
- If required, scroll to the desired item or key in a new value and press **Right ARROW** to accept it. The LCD displays the new value and the PROGRAM icon disappears.
- Press **Mode** to return to RUN mode.

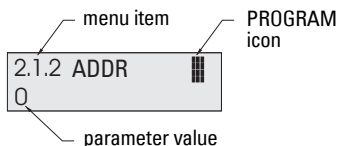





Quick Start Wizard via the handheld programmer

Notes:

- The wizard is a complete package and the settings are inter-related.
- Do not use the Quick Start wizard to modify individual parameters. See instead *Parameter Reference* on page 45. (Perform any customization only after Quick Start has been completed.)
- Changes apply only at the end of the sequence, after you select **Apply changes**.
- Each time the Quick Start Wizard is initiated, the start-up settings are factory defaults. The Wizard will not recall previous user-defined settings.

The Quick Start menu appears as soon as you activate **PROGRAM** mode.

1. Quick Start

- Point the programmer at the display [from a maximum distance of 600 mm (2 ft.)], then press **Mode**  to activate **PROGRAM** mode and open Menu level 1.
- Press **Right ARROW**  to navigate to menu item 1.1.
- Press **Right ARROW**  to open **Edit** mode: the PROGRAM icon  will flash.
- To change a setting, scroll to the desired selection or key in a new value.
- After modifying a value, press **Right ARROW**  to accept it. The LCD displays the next menu item, the PROGRAM icon disappears, and the rightmost digit flashes to indicate **Navigation Mode**.

1.1. Language

Options	ENGLISH, DEUTSCH, FRANCAIS, ESPANOL
----------------	-------------------------------------

1.2. Application Type (APPL)

Options	STEEL	Silo construction
	CONCRETE	

1.3. Operation

Options	LEVEL	Distance to material surface referenced from Low Calibration Point (process empty level).
	SPACE	Distance to High Calibration Point (process full level) referenced from material surface.
	DISTANCE	Distance to material surface referenced from Sensor Reference Point.

Operation types

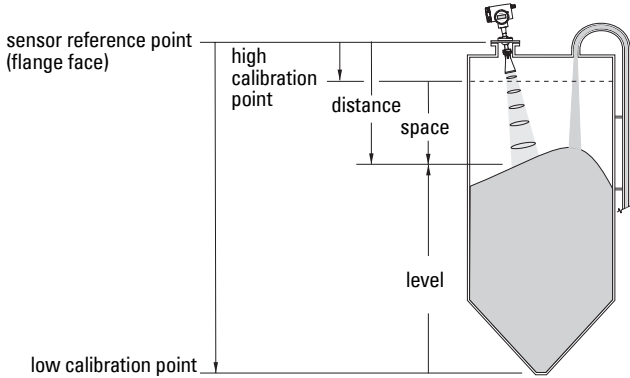

1.4. Units

Select the units for the Quick Start variables (high and low calibration point, and level, distance, or space).

Options	MM, CM, M, IN, FT
----------------	-------------------

1.5. High Calibration Point (CAL HIGH)

Distance from Sensor Reference to High Calibration Point: usually process full level. (See 1.3. Operation for an illustration.)

Values	Range	0.0000 to 100.00 m
---------------	-------	--------------------

1.6. Low Calibration Point (CAL LOW)

Distance from Sensor Reference to Low Calibration Point: usually process empty level. (See 1.3. Operation for an illustration.)

Values	Range: 0.0000 to 100.00 m
---------------	---------------------------

1.7. Rate

Sets the reaction speed of the device to measurement changes in the target range.

Options	SLOW	0.1 m/minute
	MED	1.0 m/minute
	FAST	10.0 m/minute

Use a setting just faster than the maximum filling or emptying rate (whichever is greater). Slower settings provide higher accuracy. Faster settings allow for more level fluctuation.

1.8. Apply Changes (APPLY?)

In order to save the Quick Start settings it is necessary to enable **Apply Changes**.

Options	YES, NO
----------------	---------

Select **YES**. SITRANS LR460 is now ready to operate and returns to RUN mode.

Quick Start Wizard via SIMATIC PDM

The graphical Quick Start Wizard groups together all the settings you need to make for a simple application into 4 steps.

To use HART or PROFIBUS PA, you will need a PC configuration tool: we recommend SIMATIC PDM.







Please consult the operating instructions or online help for details on using SIMATIC PDM. (Application Guides for setting up Siemens PROFIBUS PA and HART instruments with SIMATIC PDM are available on our website: www.siemens.com/processautomation.)

Device Description (DD)

You will need the DD for SIMATIC PDM version 6.0 SP3 (or higher). You can locate the newest version of the DD via our website.

- Download the DD from the product page of our website at: www.siemens.com/lr460, under **Downloads**.
- Save the files to your computer, and extract the zipped file to an easily accessed location. These files will be used in step 2 of *Configuring a new device* on page 31.

Configuring a new device

1. Set Address (default for PROFIBUS PA is 126; for HART is 0).
 - Point the handheld programmer at the display then press **Mode**  to activate **PROGRAM** mode, menu item 1.
 - Press **Down ARROW** , **Right ARROW** , **Right ARROW**  to navigate to Address [menu item **2.1.2** (HART), or **2.1.1** (PROFIBUS PA)].
 - Press **Right ARROW**  to open Edit mode: the PROGRAM icon  will flash.
 - If required, key in a new value and press **Right ARROW**  to accept it. The LCD displays the new value and the PROGRAM icon disappears.
2. You will need the most up-to-date Device Description (DD) for your instrument. Launch **SIMATIC PDM – Manage Device Catalog**, browse to the unzipped DD file that you previously downloaded (see “Device Description (DD)” on page 31), and select it. It will be loaded into the device catalog.
3. Launch **SIMATIC Manager** and create a new project for LR460. Application Guides for setting up HART and PROFIBUS PA devices with SIMATIC PDM can be downloaded from the product page of our website at: www.siemens.com/lr460
4. Open the menu **Device – Reset** and click on **Factory Defaults** and click **OK**.
5. Upload parameters to the PC/PG.
6. Calibrate the device via the Quick Start Wizard.

Quick Start Wizard steps

Notes:

- The Quick Start settings are not independent parameters. The settings are inter-related, and changes only apply when you click **Transfer** at the end of step 4.
- Do not use the Quick Start Wizard to modify individual parameters: see instead *Parameter Reference* on page 45. (Perform any customization only after Quick Start has been completed.)
- Click **BACK** to return and revise settings, or **Cancel** to exit the Quick Start.
- Dialog boxes appear as they would using a PROFIBUS PA device. Screens may appear slightly different when using a HART device.
- The layout of the dialog boxes shown may vary according to the resolution setting for your computer monitor.
- Each time the Quick Start Wizard is initiated, the start-up settings are factory defaults. The Wizard will not recall previous user-defined settings.

Open the menu **Device – Quick Start**, and follow steps 1 to 4.

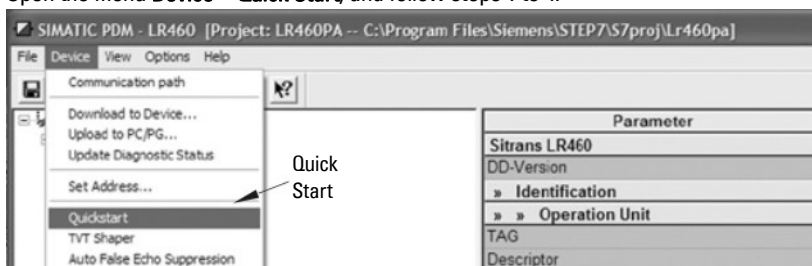

Step 1 – Identification

Click **NEXT** to accept default values. [Descriptor, Message, and Installation Date (Last config with HART device) fields can be left blank.]

* **Installation Date** field appears as **Last config** with HART device.

Step 2 – Application type

Select the application type and operation type¹ and click **NEXT**.

¹ For an illustration see *Operation types* on page 30.

Step 3 – Range Setup

Set Sensor Units, enter values for Low and High Calibration points, and select a Response Rate just faster than the maximum fill/empty rate.¹ Click **NEXT**.

Range Setup - LR 460

Range Setup

Step 1 Identification → Step 2 Application Type → Step 3 **Range Setup** → Step 4 Summary

SIEMENS

Sensor Units: meter

Low Calibration Pt. (X): 30

High Calibration Pt. (Y): 0.35

Response Rate: fast

< BACK NEXT > Cancel Help

¹. See 1.7 Rate on page 30.

Step 4 – Summary

Check parameter settings, and click **BACK** to return and revise values, or **TRANSFER** to transfer values to the device.

Summary - 460PA

Summary |

Step 1 Identification → Step 2 Application Type → Step 3 Range Setup → Step 4 Summary

SIEMENS

Application Type:

Operation:

Old Values:

TAG	<input type="text" value="460PA"/>	Language	<input type="text" value="English"/>	Low Calibration Pt.	<input type="text" value="70"/>	m
Descriptor	<input type="text" value="SITRANS_LR460_PA"/>	Response Rate	<input type="text" value="fast"/>	High Calibration Pt.	<input type="text" value="0"/>	m
Message	<input type="text"/>	Sensor Units	<input type="text" value="m"/>	Upper Value	<input type="text" value="70.00"/>	m
Installation Date	<input type="text" value="01.10.1998"/>	Unit	<input type="text" value="m"/>	Lower Value	<input type="text" value="0.00"/>	m

New Values:

TAG	<input type="text" value="460PA"/>	Language	<input type="text" value="English"/>	Low Calibration Pt. (X)	<input type="text" value="70"/>	m
Descriptor	<input type="text" value="SITRANS_LR460_PA"/>	Response Rate	<input type="text" value="fast"/>	High Calibration Pt. (Y)	<input type="text" value="0"/>	m
Message	<input type="text"/>	Sensor Units	<input type="text" value="m"/>	Upper Value	<input type="text" value="70.00"/>	m
Installation Date	<input type="text" value="01.10.1998"/>	Unit	<input type="text" value="m"/>	Lower Value	<input type="text" value="0.00"/>	m

< BACK TRANSFER Cancel Help

* **Installation Date** field appears as **Last config** with HART device.

After the values have been transferred to the device the message **Device Configuration Complete** appears. Click **OK** to upload values from the device to the PC/PG. and synchronize the device and PDM.

Level application example

The application is a steel silo containing flour that takes an average 3 hours to fill and 3 weeks to empty.

Using the Easy Aimer, the LR460 is oriented so that the emission cone is approximately perpendicular to the material surface.

Fill rate = 0.09 m/minute (15.5 / 180). Response rate has been set to **slow**: 0.1 m/minute, or slightly faster than the fill rate.

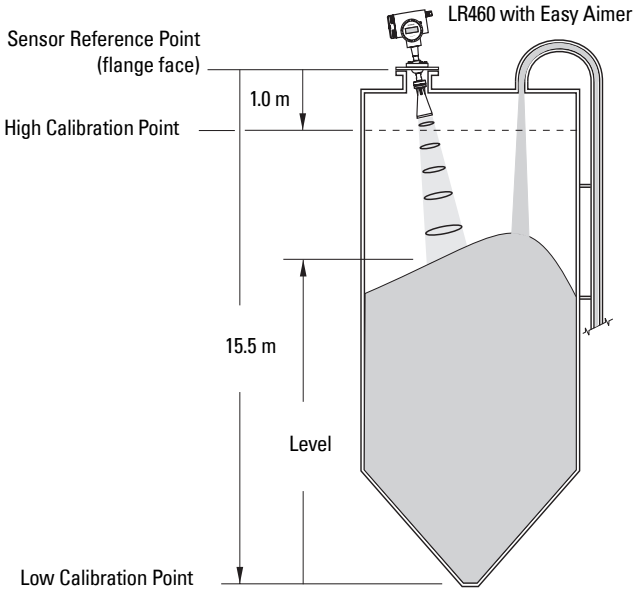

Quick Start Setting		Description
Language	ENGLISH	
Application Type	STEEL	Silo construction
Operation	LEVEL	Material level referenced from Low Calibration point.
Units	m	
High Calibration Point	1.0	Process full level.
Low Calibration Point	15.5	Process empty level.
Rate	SLOW	Response rate = 0.1 m/minute.
Apply Changes	YES	Save new settings.

Auto False Echo Suppression

If SITRANS LR460 displays a false high level, or the reading is fluctuating between the correct level and a false high level, you can use the Auto False Echo Suppression parameters to prevent false echo detection. See *TVT (Auto False Echo Suppression) Setup* on page 63 for instructions.

Operating SITRANS LR460 via SIMATIC PDM

Note: For a complete list of parameters with instructions, see *Parameter Reference starting on* page 45.

SIMATIC PDM is a software package used to commission and maintain SITRANS LR460 and other process devices. Please consult the operating instructions or online help for details on using SIMATIC PDM. (You can find more information at <https://pcs.khe.siemens.com/index.aspx?nr=3695>.)

Functions in SIMATIC PDM

SIMATIC PDM monitors the process values, alarms and status signals of the device. It allows you to display, compare, adjust, verify, and simulate process device data.

See *Accessing Functions in PDM* on page 40 for operating instructions.

Features of SIMATIC PDM Rev. 6.0 SP3 (or higher)

The graphic interface in SITRANS LR460 makes monitoring and adjustments easy.

- A graphical Quick Start wizard groups together all the settings you need to make for a simple application into four easy steps. See *Quick Start Wizard via SIMATIC PDM* on page 31.
- See *Echo profile saving and viewing* on page 38 for easy echo profile comparison.
- See *Trend Diagram (Level Trend over Time)* on page 38 for Level trend monitoring.
- See *Manual TVT Shaper* on page 39.

Note: The following dialog boxes appear as they would using a PROFIBUS PA device. Screens may appear slightly different when using a HART device.

Features of SIMATIC PDM Rev. 5.2 SP1

- SIMATIC PDM Rev. 5.2 SP1 is supported only for basic configuration and troubleshooting. (For advanced features such as the Quick Start wizard, Rev. 6.0 SP3 or higher is required.)

Echo profile saving and viewing

Note: Double click each axis and record the XScale and Data Scale values, so that you can restore the default view by resetting to these values.

- Open the menu **View – Echo Profile**.
- Press **Measure** to update an echo profile.
- After saving a profile open menu **View – Show echo profile**.

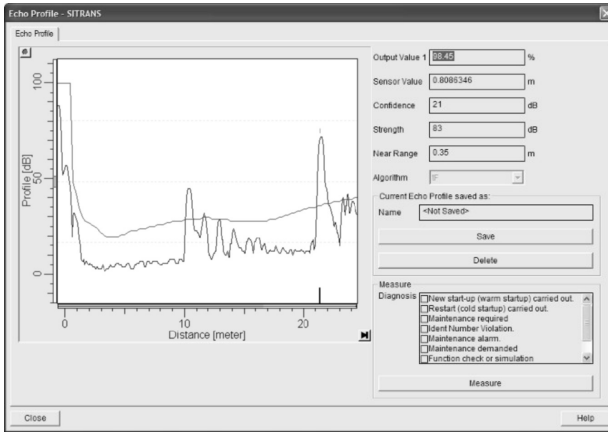

Trend Diagram (Level Trend over Time)

Note: Double click each axis and record the XScale and Data Scale values, so that you can restore the default view by resetting to these values.

Open the menu **View – Trend** to see the level trend over time.

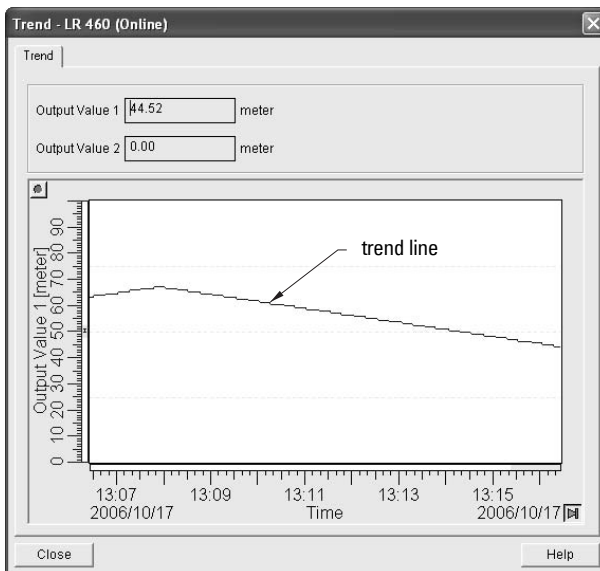

Manual TVT Shaper

Notes:

- For a more detailed explanation see *Auto False-Echo Suppression* on page 93.
- See *3.5.6. TVT (Auto False Echo Suppression) Setup* on page 63 for more instructions.
- Double click each axis and record the Xscale and Data Scale values, so that you can restore the default view by resetting to these values.

Open the menu **Device – TVT Shaper**

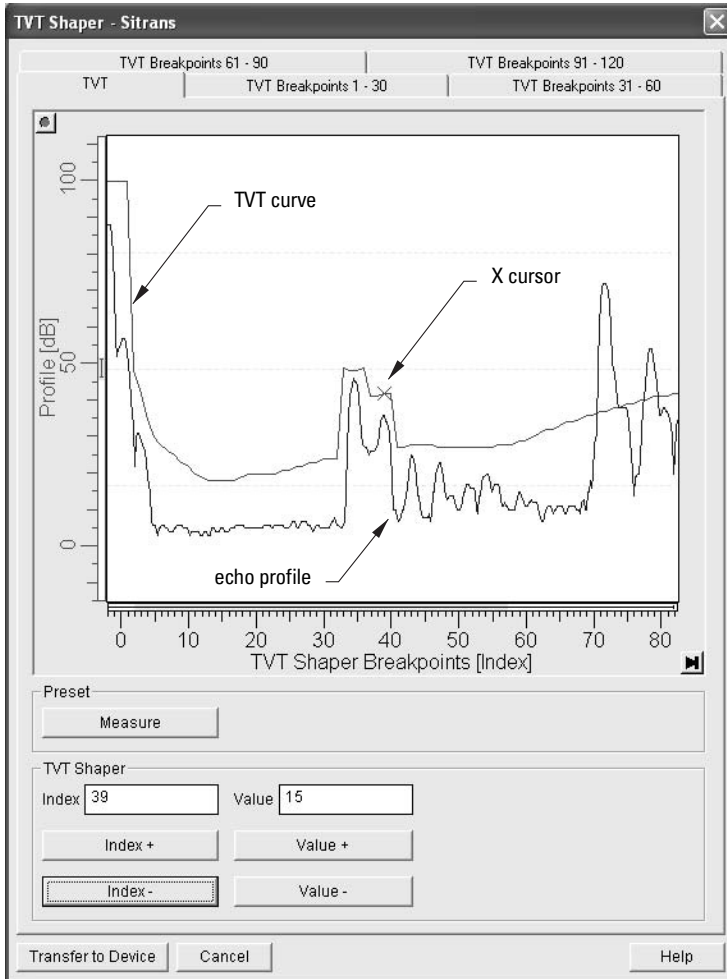

- Change the position of the X cursor on the TVT curve using the **Index+** and **Index-** buttons: raise and lower the curve using **Value+** and **Value-**.
- Alternatively, enter values directly into the dialog boxes for each breakpoint.

Accessing Functions in PDM

You have access to a number of functions via pull-down menus from the menu bar under **Device** or **View**.

For a complete list see *Pull-down menus for HART via SIMATIC PDM* on page 45 or *Pull-down menus for PROFIBUS PA via SIMATIC PDM* on page 46.

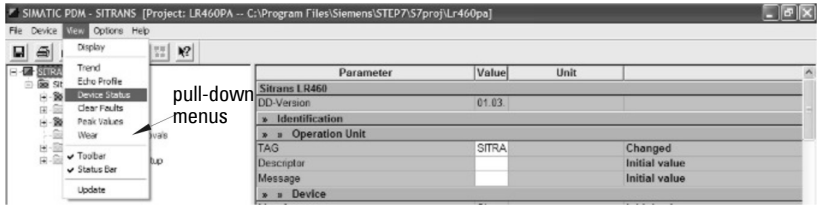

Online Display

The online display allows you to compare outputs in real time. Open the menu **View – Display**.

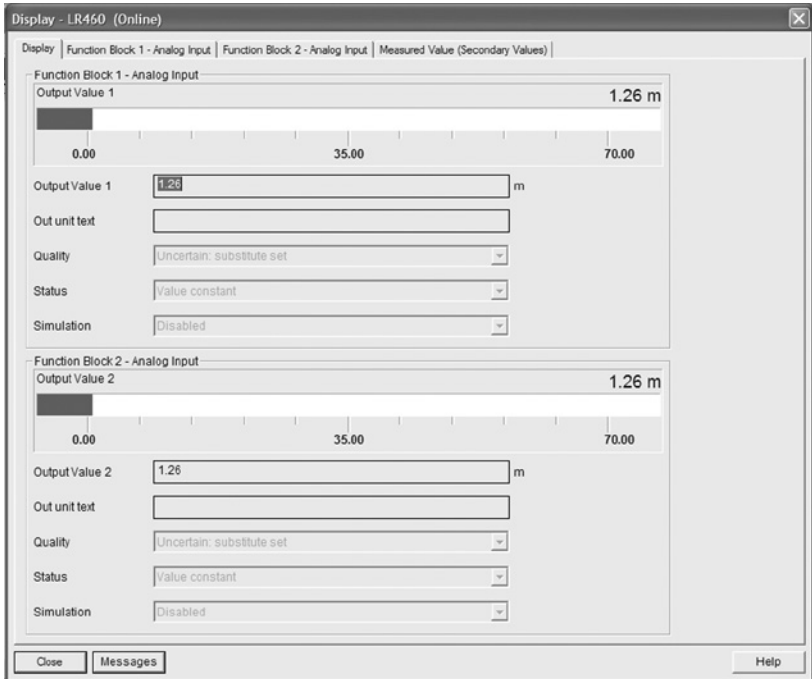

* only **Display** and **Measured Value** tabs available with HART device.

Changing parameter settings via SIMATIC PDM

Note: For a complete list of parameters, see *Parameter Reference* on page 45.

1. Launch SIMATIC PDM, connect to SITRANS LR460, and upload data from the device.
2. Adjust parameter values in the parameter value field then press **Enter**. The status fields read **Changed**.
3. Open the Device menu, click on **Download to device**, then use **File – Save**, to save parameter settings. The status fields are cleared.

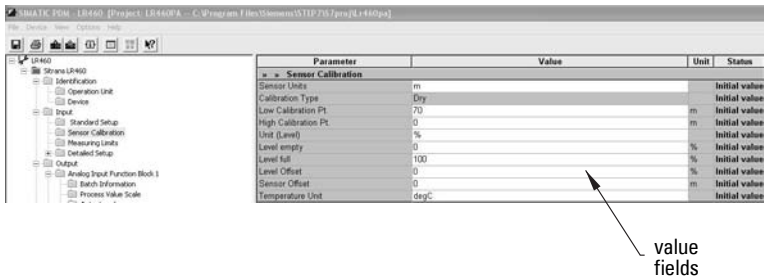

Configuring a new device

- See *Configuring a new device* on page 31 to configure your device and load the newest version of the Device Description (DD).

Calibrating LR460 via PDM

- See *Quick Start Wizard via SIMATIC PDM* on page 31 and follow 4 steps to setup for a simple application.
- For a complete list of parameters see *Parameter Reference* on page 45.

Parameters accessed via pull-down menus

See Pull-down menus for HART on page 45, and for PROFIBUS on page 46, for a complete list of parameters that can be accessed only via pull-down menus in SIMATIC PDM.

Reset¹

Factory Defaults

Use **Factory Defaults** to reset all parameters excluding tag, descriptor, message and device addresses to the default settings.

1. Open the menu **Device – Reset**, select **Factory Defaults**, and click **OK**.
2. After the reset is complete upload parameters to the PC/PG.

¹ See 2.1.5. *Reset* on page 49 for a complete list of reset options.

Warm Start

This has the same effect as cycling power. It does not reset any parameters.

- Open the menu **Device – Reset**, select **Warm Start** and click **OK**.

Configuration Flag Reset (HART only)

To reset the configuration flag to zero, open the menu **Device – Configuration Flag Reset** and execute a reset.

Auto False Echo Suppression

Use this parameter to learn a new TVT curve, to avoid false echoes caused by obstructions. See *Auto False-Echo Suppression* on page 93 for a more detailed explanation and *TVT (Auto False Echo Suppression) Setup* on page 63 for instructions.

D/A (Digital/Analog) Trim (HART only)

Allows you to trim the 4 mA and 20 mA points in order to calibrate the mA output.

Open the menu **Device – D/A Trim**. You will be prompted to attach a calibrated meter and enter the values at 4 mA and at 20 mA.

Simulate AO (Analog Output) (HART only)

Allows you to input a simulated value in order to test the functioning of the mA connections during commissioning or maintenance of the device.

To simulate a user-defined mA value:

1. Open the menu **Device – Simulate AO**.
2. Select **Other**, enter the new value, and click **OK**. The message 'Field Device fixed at new value' appears. Click **OK**.
3. When you are ready to end simulation, select **End** and click **OK** to return the device to the original output level.

Simulation

Note: The Simulation parameter influences output to the control system.

Simulate Analog Input to AIFB1 or AIFB2

Simulation (Measured Value)

Allows you to input a simulated value in order to test the functioning of the Analog Input Function Blocks.

1. Open the menu **Device – Simulation**, and select the desired function block.
2. From the **Simulation (Measured Value)** tab, enable simulation, enter a value, and click **Transfer**.
3. After simulation is complete, disable simulation.

Simulation (Output) (PROFIBUS PA only)

Allows you to simulate the output value from a Function Block.

1. Open the menu **Device – Simulation**, select the desired function block.
2. Select the **Simulation (Output)** tab.
3. Change target mode to **MAN**. Click **Transfer**.
4. Enter the simulated output value, and select values for **Quality** and **Status** as needed. Click **Transfer**.
5. After simulation is complete, change target mode back to **AUTO** and click **transfer**.

Note: When changing target mode from AUTO to MAN it is necessary to first transfer the mode to the device. Once the device is set to manual mode, then transfer the value and status to be set for simulation.

Simulate Input

Allows you to simulate the sensor value which is input to the Level Transducer Block. This tests everything between the Level Transducer Block and Output.

1. Open the menu **Device – Simulation**, and select **Simulation (Input)**.
2. To enable simulation select **Fixed** or **Ramp**.
If you select Ramp, enter the step length and number of steps.
3. Enter the simulated value and click **Transfer**.
4. After simulation is complete, disable simulation.

Notes:

Parameter Reference

Parameter menus

The parameters are grouped in menus according to function. Submenus arranged on four levels give access to associated features and options.

Parameters accessible via the handheld programmer are preceded by a number. (See *LCD Menu Structure* on page 145 for a chart.) Parameters not preceded by a number are accessible only via SIMATIC PDM.

Some parameters are accessible in SIMATIC PDM via pull-down menus. Where those parameters can also be accessed via the handheld programmer, they are found in the numbered list, and directions for PDM are given beside the individual parameter. Page references for further information can be found under *Pull-down menus for HART via SIMATIC PDM* below.

Notes:

- Default settings in the parameter tables are indicated with an asterisk (*) unless explicitly stated.
- For Quick Access to parameters via the handheld programmer, press **Mode**  to activate PROGRAM mode, then key in the menu number. (For details see *PROGRAMMING via the handheld programmer* on page 108.)
- Values shown in the following tables can be entered via the handheld programmer.

Pull-down menus for HART via SIMATIC PDM

Device menus	page	View menus	page
Communication path	-	Display	40
		Trend	38
		Echo Profile	38
		Show Echo Profile*	38
Download to Device	-	Status	-
Upload to PC/PG	-	Read Analog Value	-
Update Diagnostic Status	-	Clear Faults	-
		Peak Values	58
		Wear	55
Quickstart	47		
TVT Shaper	39	Toolbar	-
Auto False Echo Suppression	42	Status Bar	-
Maintenance	77		
Selftest	-		
Reset	41		
Configuration Flag Reset	42		
D/A Trim	42	Update	-
Write Locking	54		
Simulate AO	42		
HART Communication	112		
Simulation	42		

* Displays only if a profile has been saved

Pull-down menus for PROFIBUS PA via SIMATIC PDM

Device menus	page	View menus	page
Communication path	-	Display	40
Download to Device Upload to PC/PG Update Diagnostic Status	-	Trend	38
		Echo Profile	38
		Show Echo Profile*	38
		Device Status	-
		Clear Faults	-
	-	Peak Values	58
		Wear	55
Set Address	41	Toolbar Status Bar	- -
Quickstart	47	Update	-
TVT Shaper	39		
Auto False Echo Suppression	42		
Maintenance	77		
Reset	41		
Write Locking	54		
Simulation	42		

* Displays only if a profile has been saved

Note: The following dialog boxes appear as they would using a PROFIBUS PA device. Screens may appear slightly different when using a HART device.

Quick Start Wizard

The Quick Start wizard groups together all the settings you need to make for a simple application.

- The wizard is a complete package and settings are inter-related.
- Do not use the wizard to modify individual parameters. (Perform any customization only after Quick Start has been completed.)
- You can access the Quick Start wizard either via SIMATIC PDM, or via the handheld programmer.
- Each time the Quick Start Wizard is initiated, the start-up settings are factory defaults. The Wizard will not recall previous user-defined settings.

1. Quick Start

In SIMATIC PDM, Open the menu **Device – Quick Start**, and follow steps 1 to 4.

If you are using the handheld programmer, activate program mode and work through the Quick Start sequence.

1.1. Language

Options	ENGLISH, DEUTSCH, FRANCAIS, ESPANOL
----------------	-------------------------------------

1.2. Application Type (APPL)

Options	STEEL	Silo construction
	CONCRETE	

1.3. Operation

Options	LEVEL	Distance to material surface referenced from Low Calibration Point (process empty level).
	SPACE	Distance to High Calibration Point (process full level) referenced from material surface.
	DISTANCE	Distance to material surface referenced from Sensor Reference Point.

Operation types

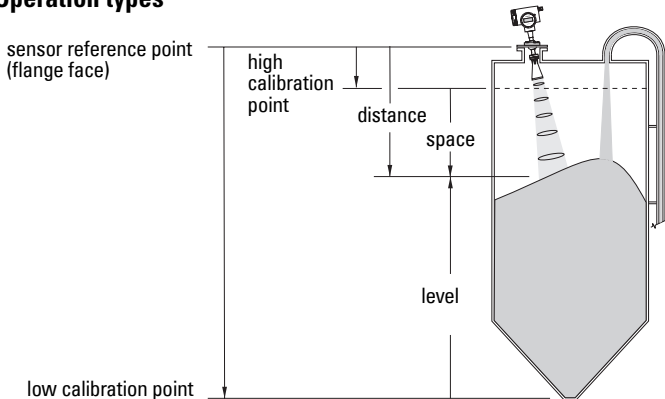

1.4. Sensor Units (UNITS)

Select the units for the Quick Start variables (high and low calibration point, and level, distance, or space).

Options	MM, CM, M, IN, FT
----------------	-------------------

1.5. High Calibration Point (CAL HIGH)

Distance from Sensor Reference to High Calibration Point: usually process full level (see illustration to 1.3)

Values	Range: 0.0000 to 100.00 m
---------------	---------------------------

1.6. Low Calibration Point (CAL LOW)

Distance from Sensor Reference to Low Calibration Point: usually process empty level (see illustration to 1.3)

Values	Range: 0.0000 to 100.00 m
---------------	---------------------------

1.7. Response Rate (RATE)

Sets the reaction speed of the device to measurement changes in the target range.

Options	SLOW	0.1 m/minute
	MED	1.0 m/minute
	FAST	10.0 m/minute

Use a setting just faster than the maximum filling or emptying rate (whichever is greater). Slower settings provide higher accuracy: faster settings allow for more level fluctuation

1.8. Apply Changes (APPLY?)

In order to save the settings changed in the Quick Start wizard it is necessary to enable **Apply Changes**.

Options	YES, NO
----------------	---------

Note: Default settings in the parameter tables are indicated with an asterisk (*) unless explicitly stated

2. Identification (IDENT)

Operation Unit

Tag

Text that can be used in any way, for example as a unique label for a field device in the plant.

Descriptor

Text that is associated with the Field Device. This text can be used by the user in any way. There is no specific recommended use.

Message

Text that is associated with the Field Device. This text can be used by the user in any way. There is no specific recommended use.

2.1. Configuration (CONFIG) (for HART devices)







See *Configuration (CONFIG) (for PROFIBUS PA devices) 2.1.* on page 51 to configure PROFIBUS PA devices. Note that menu numbers are different within Configuration for PROFIBUS PA and HART.

2.1.2. Address (ADDR)

The unique address of the device on the network (HART address).

Values	HART	0 to 15,default: 0
---------------	------	--------------------

To set the address via the handheld programmer:

- Press **Mode**  to activate **PROGRAM** mode, menu item **1.0**.
- Press **Down ARROW** , **Right ARROW** , **Right ARROW**  to navigate to Address.
- Press **Right ARROW**  to open Edit mode: the PROGRAM icon  will flash.
- If required, key in a new value and press **Right ARROW**  to accept it.

2.1.3. Remote operation enable (REMLOCK)

Enables or disables programming via the network and PDM.

Handheld programmer Values	0	*	Remote operation enabled
	1		Remote operation disabled

2.1.5. Reset

Notes:

- After resetting to factory defaults, complete reprogramming is required.
- Resetting to factory defaults does not clear values in the Quick Start Wizard: they can be re-applied.
- Performing a Warm Start clears all values from the Quick Start Wizard.

Two Reset options are available via SIMATIC PDM. Selecting **Factory Defaults** resets all parameters excluding device addresses to default values. **Reset (Warm Start)** has the same effect as recycling power.

	HART	Description
Handheld Programmer Options (PDM)	NONE ¹	No reset performed.
	FACTORY (Factory defaults)	Resets all parameters to the manufacturer's default settings with the following exceptions: <ul style="list-style-type: none"> • tag, descriptor, message and device addresses are not reset • Lock and Unlock values are not reset • the learned TVT curve is not lost
	WARM START	Has the same effect as cycling power to the device.

¹This option is not available via SIMATIC PDM.

To perform a Reset via the handheld programmer:

- Press **Mode** to open PROGRAM mode, and key in **215** for Quick Access, or use ARROW keys to navigate to **Reset**.
- Press **RIGHT Arrow** to open Edit Mode.
- Press **DOWN Arrow** to scroll to **FACTORY** and **RIGHT Arrow** to select it. After the Reset is performed, the display will return to **NONE**.
- Press **Mode** to return to Measurement Mode.

To perform a Reset via SIMATIC PDM:

Open the menu **Device – Reset**, and select **Factory Defaults** or **Warm Start** (for more detail see *Warm Start* on page 42).

2.1.6. Clear Faults (ACK FAULT)

Resets the Fault message after an active fault has occurred and been corrected. This is required only for maintenance faults and faults listed as requiring a manual reset in the General Fault Code list (see page 102).

Open the menu **View – Clear Faults**. You will see the fault listed. Click Transfer.

To perform a Reset via the handheld programmer:

- Press **Mode** to open PROGRAM mode, and key in **216** for Quick Access, or use ARROW keys to navigate to menu **IDENT–CONFIG–ACK FAULT**.
- Key in the number of the fault you want to clear.
- Press **RIGHT Arrow** to enter the code. The fault code will disappear.
- Press **Mode** to return to Measurement Mode.

2.1.7. Menu Timer

Determines the length of time (in seconds) the device will stay in PROGRAM mode without any key presses occurring.

2.1.8. Backlight

Controls the setting for the LCD backlight feature.

Handheld programmer Values	0		Backlight off
	1		Backlight on
	2	*	Backlight remains illuminated for 3 minutes from last key press.

2.1. Configuration (CONFIG) (for PROFIBUS PA devices)







See *Configuration (CONFIG) (for HART devices) 2.1.* on page 49 to configure HART devices. Note that menu numbers are different within Configuration for PROFIBUS PA and HART.

2.1.1. Address (ADDR)

The unique address of the device on the network (PROFIBUS address).

Values	PROFIBUS PA	0 - 126, default: 126 (We recommend a setting in the range 1 to 125.)
---------------	-------------	-----------------------------------------------------------------------

To set the address via the handheld programmer:

- Press **Mode**  to activate **PROGRAM** mode, menu item **1.0**.
- Press **Down ARROW** , **Right ARROW** , **Right ARROW**  to navigate to Address.
- Press **Right ARROW**  to open Edit mode: the PROGRAM icon  will flash.
- If required, key in a new value and press **Right ARROW**  to accept it.

To set Address via PDM:

Open the menu **Device – Set Address**.

2.1.3. Remote operation enable (REMLOCK)

Enables or disables programming via the network and PDM.

Handheld programmer Values	0	*	Remote operation enabled
	1		Remote operation disabled

2.1.4. Reset

Notes:

- After resetting to factory defaults, complete reprogramming is required.
- Resetting to factory defaults does not clear values in the Quick Start Wizard: they can be re-applied.
- Performing a Warm Start clears all values from the Quick Start Wizard.

	PROFIBUS	Description
PDM Options (device)	Factory defaults (FACTORY)	Resets all parameters to the manufacturer's default settings with the following exceptions: <ul style="list-style-type: none"> • tag, descriptor, message and device addresses are not reset • Lock and Unlock values are not reset • the learned TVT curve is not lost
	Standard Defaults (STANDARD)	Resets all parameters excluding device addresses to the PROFIBUS standard default settings.
	Informational Reset (INFO)	Resets Tag.
	Functional Reset (FUNCTIONAL)	Resets parameters that control device behaviour and functionality (such as calibration points).
	Warm start (WARM START)	Has the same effect as cycling power to the device.
	Reset Address to 126 (ADDRESS)	<ul style="list-style-type: none"> • Reset PROFIBUS device address to 126. • If the address lock was on, this will disable the lock.

To perform a Reset via the handheld programmer:

- Press **Mode** to open PROGRAM mode, and key in **214** for Quick Access, or use ARROW keys to navigate to **Reset**.
- Press **RIGHT Arrow** to open Edit Mode.
- Press **DOWN Arrow** to scroll to the desired option from table above and **RIGHT Arrow** to select it. After the Reset is performed, the display will return to NONE.
- Press **Mode** to return to Measurement Mode.

To perform a Reset via SIMATIC PDM:

Open the menu **Device – Reset**, and select the desired option from the table above.

2.1.6. Clear Faults (ACK FAULT)

Resets the Fault message after an active fault has occurred and been corrected. This is required only for maintenance faults. See General Fault Code list (page 102).

Open the menu **View – Clear Faults**. You will see the fault listed. Click Transfer.

To perform a Reset via the handheld programmer:

- Press **Mode** to open PROGRAM mode, and key in **216** for Quick Access, or use ARROW keys to navigate to menu **IDENT–CONFIG–ACK FAULT**.
- Key in the number of the fault you want to clear.
- Press **RIGHT Arrow** to enter the code. The fault code will disappear.
- Press **Mode** to return to Measurement Mode.

2.1.7. Menu Timer

Determines the length of time (in seconds) the device will stay in PROGRAM mode without any key presses occurring.

Values	Range: 15 to 65535 (seconds)
	Default: 120 (seconds)

2.1.8. Backlight

Controls the setting for the LCD backlight feature.

Handheld programmer Values	0	Backlight off
	1	Backlight on
	2	* Backlight remains illuminated for 3 minutes from last key press.

2.2. Device**Manufacturer**

References a specific manufacturer, usually the name of the company responsible for the manufacture of this Field Device.

Product designation

Uniquely identifies the Field Device when combined with the Manufacturer Identification and Device Type. This variable cannot be modified by the Host user.

Device Serial Num

Uniquely identifies the Field Device. This variable cannot be modified by the Host.

Order No.

The order number for this device.

Date of Birth

Date of manufacture.

2.2.1. Software Revision (SOFT REV)

Corresponds to the software or firmware that is embedded in the Field Device.

2.2.2. Hardware Revision (HARD REV)

Corresponds to the electronics hardware of the Field Device.

Profile Revision (PROFIBUS PA only)

PROFIBUS PA Profile standard that this device conforms to.

Static Revision No. (PROFIBUS PA only)

The revision level of the static data associated with the Physical Block. The Static Revision No. is updated whenever a standard profile configuration parameter is changed.

2.2.3. PROFIBUS Ident Number (IDENT NUM) (PROFIBUS PA only)

Identifies the device on the network. The Ident Number must match that in the GSD file (the GSD file provides information on the device to the master).

Values	0		Profile-specific [uses generic GSD for 2 AIFB (ident # = 0x9701)]
	1	*	Manufacturer-specific [uses Siemens DD and GSD file, which identifies the LR460 (PROFIBUS PA)] (ident # = 0x8132)
	128		Profile-specific [uses generic GSD for 1 AIFB (ident # = 0x9700)]

Installation Date (PROFIBUS PA); Last config (HART)

Date on which the device was installed. The user must enter the date.

Local Operation Enable

Enables/disables programming the device via the handheld programmer. When disabled, the user still has access to the mode control of the two Analog Input Function Blocks.

2.2.4. Write Locking (LOCK)

Prevents any changes to parameters via PDM or the handheld programmer.

	Handheld Programmer Options		PDM Options with PROFIBUS PA	PDM Options with HART	Description
Options	UNLOCKED	*	OFF	Changes allowed	programming enabled
	LOCKED		ON	Changes disallowed	programming disabled

Open the menu **Device – Write Locking**, and select desired option.

2.2.5. Language

Selects the language to be used on the LCD.

Options	*	ENGLISH	English
		DEUTSCH	German
		FRANCAIS	French
		ESPANOL	Spanish

2.3. Statistics (STATS)

To view Statistics via PDM, open the menu **View – Wear**.

2.3.1. Total Device Operating Time (PWRD HOURS)

Number of hours the unit has been powered up since manufacture.

2.3.2. Poweron Resets (RESETS)

The number of power cycles that have occurred since manufacture.

3. Input

Static Revision Number

The revision level of the static data associated with the Level Transducer Block, updated whenever a configuration parameter is changed.

Class

Indicates the Level Transducer Block as per PROFIBUS PA Profile specifications.

3.2. Standard Setup (ST SETUP)

3.2.1. Antenna

Identifies antenna configuration.

Options	NO HORN
	3 IN
	4 IN

3.2.2. Response Rate (RESPRATE)

Sets the reaction speed of the device to measurement changes in the target range.

Related parameters	Response Rate	LOE Timer¹ (minutes)	Fill Rate	Empty Rate
Values	* SLOW	100	0.1 m/minute	0.1 m/minute
	MED	10	1 m/minute	1 m/minute
	FAST	1	10 m/minute	10 m/minute

Note: If you change Response Rate it resets the following parameters: LOE Timer, Fill Rate, and Empty Rate.

Use a setting just faster than the maximum filling or emptying rate (whichever is greater). Slower settings provide higher accuracy and a smoother output signal; faster settings allow for more level fluctuation.

¹ For instructions on usage see 3.5.1.1. *LOE (Loss of Echo) Timer (LOE TIME)*. For technical details see *LOE Timer*.

3.3. Sensor Calibration (SENSOR CAL)

To perform calibration for a simple application go to *Quick Start Wizard via the handheld programmer* on page 29 or *Quick Start Wizard via SIMATIC PDM* on page 31.

To modify an individual parameter setting, do not use the Quick Start wizard.

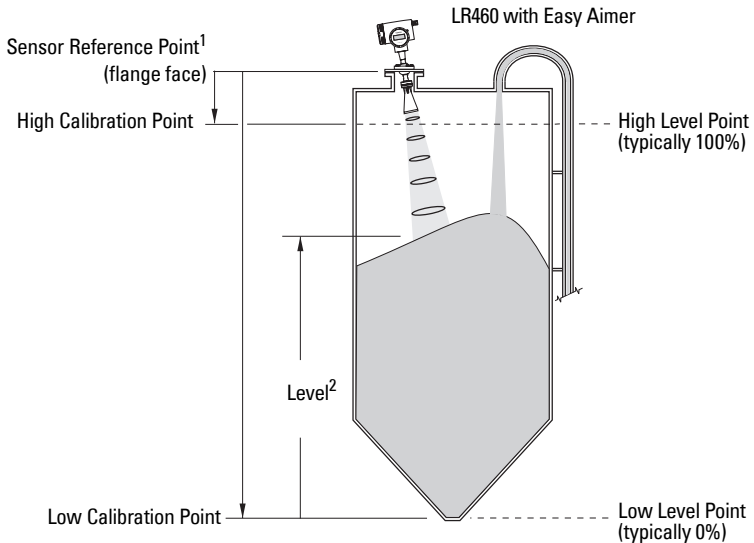

3.3.1. Sensor Units (SENS UNIT)

Whatever units the sensor is measuring in.

Options	M, IN, CM, MM, FT
	default: m

3.3.2. Calibration Type (CAL TYPE)

In Dry calibration, the user enters all four calibration values: High and Low Level Points, and High and Low Calibration Points.

Options	DRY	*	Dry calibration
----------------	-----	---	-----------------

3.3.3. Low Calibration Pt. (CAL LO)

Distance from Sensor Reference to Low Calibration Point (corresponding to Low Level Point). Unit is defined in Sensor units.

Values	3" HORN	default: 70 m (229.7 ft)
	4" HORN	default: 100 m (328.1 ft)

1. Sensor Reference Point: the point to which all the Sensor Calibration parameters are referenced, which is the flange face.
2. Level Value: the level measured in level units.

3.3.4. High Calibration Pt. (CAL HIGH)

Distance from Sensor Reference to High Calibration Point (corresponding to High Level Point). Unit is defined in Sensor units.

Values	Range: 0 to 100 m
	Default: 0 m

3.3.5. Unit (Level) (LVL UNIT)

Selected engineering units for Level (PV), referenced from Low Level Point (plus level offset, if any).

Options	percent linear	% M, IN, CM, MM, FT, IN, M3, L, HL, IN3, FT3, YD3, GAL, IGAL, BUSH, BBL, BBL (LIQ)
	default: %	

3.3.6. Level empty (PA); Low Level Point (HART) (LV MIN)

The level when the material is at Low Calibration Point. The unit is defined in Level units.

Values	Range: -999999 to 999999 %
	Default: 0 %

3.3.7. Level full (PA); High Level Point (HART) (UV MAX)

The level when the material is at High Calibration Point. The unit is defined in Level units.

Values	Range: -999999 to 999999 %
	Default: 100 %

3.3.8. Level Offset (LEV OFFSET)

A constant offset that can be added to Level to form PV/SV1 (default level output). See page 133 for an illustration. The unit is defined in Level units.

Values	Range: -999999 to 999999 %
	Default: 0 %

3.3.9. Sensor Offset (SEN OFFSET)

The offset from the Sensor's reference point to the vessel's reference point. This is a constant offset that is added to the Sensor value. The unit is defined in Sensor Units. (See How the Level Transducer Block works: on page 132 for further details.)

Compensates, for example if the sensor head is changed.

Values	Range: -999999 to 999999 m
	Default: 0 m

3.3.A. Temperature Units (TEMP UNIT)

Selects the engineering unit to be displayed with the value representing temperature.

Options	C, F, R, K
	default: °C

3.4. Measuring Limits (MEAS LIM)

You can view maximum and minimum values for the sensor values and the process temperature.

In SIMATIC PDM open the menu **View – Peak Values**, and click on the appropriate tab.

3.4.1. Min. Measured Value (MEAS MIN)¹

The minimum recorded Sensor value, defined in Sensor units.

Open the menu **View – Peak Values** and select the tab **Sensor**. If necessary, click on the **Reset** button which will reset both the min. and max. values.

3.4.2. Max. Measured Value (MEAS MAX)¹

The maximum recorded Sensor value, defined in Sensor units.

Open the menu **View – Peak Values** and select the tab **Sensor**. If necessary, click on the **Reset** button which will reset both the min. and max. values.

3.4.3. Min. Sensor Value (LV MIN) (default 0.000) (PROFIBUS PA only)

Defines the minimum usable value for the measuring range (physical limit of the sensor) in Sensor units. (Read only - not available through Peak Values menu.)

3.4.4. Max. Sensor Value (UV MAX) (default 100.000) (PROFIBUS PA only)

Defines the maximum usable value for the measuring range (physical limit of the sensor) in Sensor units. (Read only - not available through Peak Values menu.)

3.4.5. Internal Temperature Min. (PROC T MIN)

The minimum recorded temperature of the internal electronics.

Open the menu **View – Peak Values** and select the tab **Temperature**. If necessary, click on the **Reset** button which will reset both the min. and max. values.

3.4.6. Internal Temperature Max. (PROC T MAX)

The maximum recorded temperature of the internal electronics.

Open the menu **View – Peak Values** and select the tab **Temperature**. If necessary, click on the **Reset** button which will reset both the min. and max. values.

¹ In PDM, open View menu, scroll down to Peak Values, and click Sensor tab.

3.5. Detailed Setup (DT SETUP)

3.5.1. Fail-safe

3.5.1.1. LOE (Loss of Echo) Timer (LOE TIME)

Amount of time, in minutes, that a Loss of Echo must persist, before the device goes into Fail-safe mode. See *Fail-safe Mode* for more details.

Values	Range: 0.00 to 720 (minutes)
	Default: 10.000

3.5.1.2. Restrict rate out of LOE (Loss of Echo) (RESTRICT)

Restricts the rate at which the detected echo is reported when a LOE condition ends, to prevent an immediate jump to the new echo. The rate of restriction is the same as the response (fill/empty) rate.

Options	YES	on
	NO	off
	Default: YES	

3.5.2. Echo Select (ECHO SEL)

3.5.2.1. Algorithm

Selects the algorithm to be applied to the echo profile to extract the true echo.

Options	TF	First echo above TVT is selected.
	ALF	Area, Largest, and First combination
	A	long range Area only
	L	long range Largest only
	* F	First large echo
	AL	Area and Largest average
	AF	long range Area and First average
	LF	long range Largest and First average
	BLF	Best of First and Largest
	BL	Best of Largest
	BF	Best of First
	LAST	Last
Related parameters	<ul style="list-style-type: none"> • 3.6.2.1. Echo Confidence Long (ECHO CON L) • 3.5.2.4. Narrow Echo Filter (NARROW FLT) • 3.5.2.5. Reform Echo (REFORM) 	

Use Echo Confidence to determine which algorithm gives the highest confidence under all level conditions. If the wrong echo is processed, observe the echo processing displays and select an alternate algorithm.

3.5.2.2. Threshold Long (THRSH LONG)

Sets the minimum echo confidence that the echo must meet in order to prevent a Loss of Echo condition and the expiration of the LOE timer. When Echo Confidence exceeds the Confidence Threshold, the echo is evaluated.

Values	Range: 0 to 99
	Default: 10
Related Parameters	LOE Timer

Use this feature when an incorrect material level is reported.

3.5.2.3. Echo Marker (MARKER)

The point on the selected echo from which the measured value is taken.

Values	Range: 0 to 95
	Default: 90

3.5.2.4. Narrow Echo Filter (NARROW FLT)

Filters out echoes of a specific width.

Values	0 = OFF
	default = 0
	greater = wider
Related Parameters	<ul style="list-style-type: none">• 3.6.2.1. Echo Confidence Long (ECHO CON L)• 3.5.2.5. Reform Echo (REFORM)

To remove a false echo from the Echo Profile, take its width in mm and multiply it by 0.014. Enter the result.

For example, to filter out a spike with 500 mm width enter 7 (the sum of 500 x 0.014).

When a value is keyed in, the nearest acceptable value is entered.

3.5.2.5. Reform Echo (REFORM)

Smooths jagged peaks in the echo profile. Reforms fragmented echoes into one echo.

Values	0 = OFF
	Default = 0
	Greater = Wider Recommended range 10 to 20: higher is not recommended.
Related Parameters	<ul style="list-style-type: none">• Material• 3.5.2.1. Algorithm• 3.5.2.4. Narrow Echo Filter (NARROW FLT)• 3.5.2.3. Echo Marker (MARKER)

Use this feature when monitoring solids, if the reported level fluctuates slightly even though the monitored surface is still.

Enter the amount of smoothing required. When a value is keyed in, the nearest acceptable value is entered.

3.5.2.6. Position Detect (E POS)

The point on the selected echo from which the measured value is taken.

Options	*	CENTER
		RISING

Note: The parameter default of CENTER is changed to RISING when using the Quick Start Wizard. This provides a more reliable distance measurement reading for Quick Start applications. (Manually changing the default back to CENTER can cause a change in the reading.)

3.5.3. Sampling (ECHO SAMP)

3.5.3.1. Window

A "distance window" centered on the echo, used to derive the reading. When a new measurement is in the window, the window is re-centered and the reading is calculated.

When the value is 0, the window is automatically calculated after each measurement.

- For slower Measurement Response values, the window is narrow.
- For faster Measurement Response values, the window becomes progressively wider.

Values	Range: 0 to 20
	Default: 0

3.5.3.2. Window Used (WIND USED)

Displays the size of the window used for the previous measurement. Window used is the closest usable window size, depending on the device measurement resolution.

For example, if window = 1 m, the window used might be 0.96 m.

3.5.3.3. Shots

The number of echo profile samples averaged to produce a measurement.

Values	Range: 1 to 25
	Default: 15

3.5.4. Range

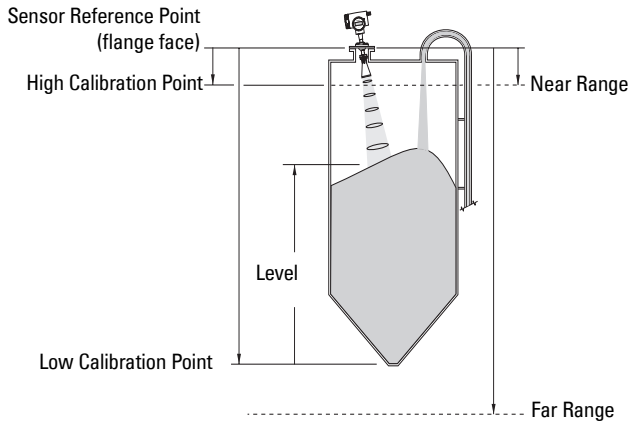

3.5.4.1. Near Range

The range in front of the device (referenced from the flange face) within which any echoes will be ignored. (This is sometimes referred to as **Blanking or Dead Zone.**)

Values	Range: 0 to 103 m max.	
	3" HORN	default: 0.278 m (0.9 ft)
	4" HORN	default: 0.335 m (1.1 ft)

The default setting of 0.6 m avoids a false echo being triggered by condensation or other material buildup. If no buildup is anticipated (for example, with dry cement) then the minimum setting 0.35 m can be used.

3.5.4.2. Far Range

Note: Far Range can extend beyond the bottom of the vessel.

Maximum distance from the reference point, within which an echo should be considered valid.

Values	Range: 0 to 103 m max.
	Default: The value of Low Calibration Point plus 3 m (9.8 ft)

3.5.6. TVT (Auto False Echo Suppression) Setup

Note: If the Reform parameter has been used to reshape the echo profile, Auto False Echo Suppression must be re-enabled, to relearn the TVT curve

SITRANS LR460 first learns the echo profile. Then the learned profile, or part of it, is used to screen out false echoes. (See Auto False-Echo Suppression on page 93 for a more detailed explanation.)

3.5.6.1. Auto False Echo Suppression (AUTO TVT)

Values	OFF	
	ON	Enable Auto False Echo Suppression
	LEARN	"Learn" the TVT curve
Related parameters	<ul style="list-style-type: none">• 3.5.2.5. Reform Echo (REFORM)	

To use Auto False Echo Suppression via SIMATIC PDM:

- a. Determine **Range** (the distance within which the learned TVT will replace the default TVT). Measure the actual distance from the antenna reference point to the material surface using a rope or tape measure, and make allowances for the actual location of the LR460. Subtract 2 m (6.56 ft) from this distance, and use the resulting value.
- b. Open the menu **Device – Auto False Echo Suppression**.
- c. Enter the value for **Range** and click **Set Range**.
- d. Click **Learn**. The **On** and **Off** buttons disappear while the new curve is being learned.
- e. When the buttons reappear, click **Close**. Auto TVT is now on, and the learned TVT curve will be used.
- f. To turn Auto False Echo Suppression off or on, reopen menu **Device – Auto TVT** and click **On** or **Off**.

To use Auto False Echo Suppression via the handheld programmer:

- a. See *3.5.6.2. Range (Auto False Echo Suppression Distance)*, step **a** below and enter the value.
- b. Select **Learn**. The device will automatically revert to On (Use Learned TVT) after a few seconds.

3.5.6.2. Range (Auto False Echo Suppression Distance)

Defines the endpoint of the Learned TVT distance.

- a. Determine the actual distance from the antenna reference point to the material surface. Use a rope or tape measure, and make allowances for the actual location of the LR460. Subtract 2 m (6.56 ft) from this distance, and use the resulting value.
- b. Enter the value for **Range** and press Right Arrow to accept it.
- c. Go to *3.5.6.1. Auto False Echo Suppression (AUTO TVT)*. step **b**.

Values	Range: 0 to 100 m
	Default: 1 m

Display before Auto False Echo Suppression

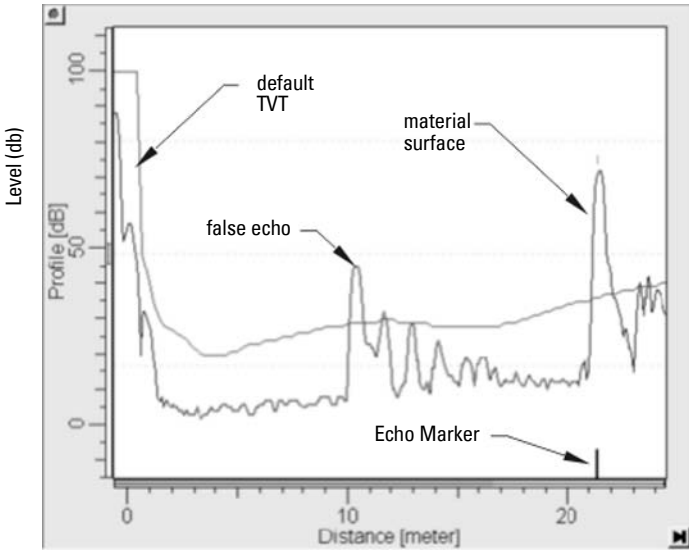

Example after Auto False Echo Suppression

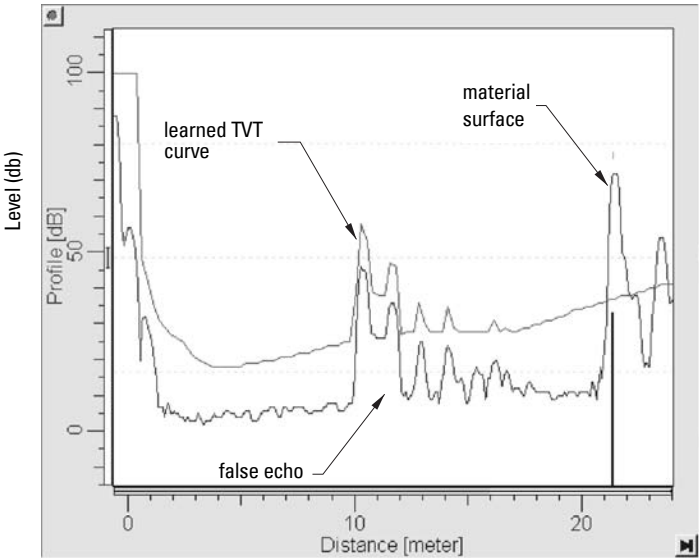

3.5.6.3. TVT Hover Level (TVT HOVER)

Defines in percent how high the TVT (Time Varying Threshold) curve is placed above the echo profile, with respect to largest echo.

Values	Range: 0 to 100%
	Default: 33%

3.5.6.4. Shaper Mode (SHAPER MD)

Enables the TVT curve to be manually adjusted at a specified range.

Options		ON
	*	OFF

3.5.7. TVT Shaper

You can manually adjust the TVT curve by entering values for up to 120 breakpoints on the curve.

Values	Range: -50 to +50
	Preset: 0
Related	• <i>3.5.6.4. Shaper Mode (SHAPER MD)</i>

Use this feature to bias the shape of the TVT curve to avoid selecting false echoes from fixed objects.

Each breakpoint is normalized to a value of **0**. Change the value of the breakpoints to adjust the curve. In the case of multiple false echoes, shaping can be applied along different points of the curve. Shaping should be applied sparingly in order to avoid missing the true echo.

The Manual TVT shaper feature allows you to adjust the TVT curve while viewing the echo profile.

To change a breakpoint via PDM:

- Confirm that Shaper Mode is selected.
- Open the menu **Device – TVT Shaper** then either adjust the curve manually, or enter values for the desired breakpoints. (See *Manual TVT Shaper* on page 39.)

To change a breakpoint via the handheld programmer:

- Confirm that Shaper Mode is selected.
- Access the submenu for the breakpoint number in question and enter values for all desired breakpoints.

3.5.7.1. Shaper A (1 - 9)

3.5.7.2. Shaper B (10 - 18)

3.5.7.3. Shaper C (19 - 27)

- 3.5.7.4. Shaper D (28 - 36)
- 3.5.7.5. Shaper E (37 - 45)
- 3.5.7.6. Shaper F (46 - 54)
- 3.5.7.7. Shaper G (55 - 63)
- 3.5.7.8. Shaper H (64 - 72)
- 3.5.7.9. Shaper I (73 - 81)
- 3.5.7.A. Shaper J (82 - 90)
- 3.5.7.B. Shaper K (91 - 99)
- 3.5.7.C. Shaper L (100 - 108)
- 3.5.7.D. Shaper M (109 - 117)
- 3.5.7.E. Shaper N (118 - 120)

3.5.8. Rate

3.5.8.1. Fill Rate (/min) (FILL RATE)

Defines the maximum rate at which the reported sensor value is allowed to increase. Allows you to further adjust the LR460 response to increases in the actual material level. Fill Rate is automatically updated whenever Response Rate is altered.

Values	Range: 0.0000 to 99999 m / min.
	Default: 10.000
Altered by	Response Rate
Related	Unit (Level) High Level Point

Enter a value slightly greater than the maximum vessel-filling rate, in Sensor Units per minute.

3.5.8.2. Empty Rate (/min) (EMPTY RATE)

Defines the maximum rate at which the reported sensor value is allowed to decrease. Adjusts the LR460 response to decreases in the actual material level. Empty Rate is automatically updated whenever Response Rate is altered.

Values	Range: 0.0000 to 99999 m / min.
	Default: 10.000
Altered by	Response Rate
Related	Units (Level) High Level Point

Enter a value slightly greater than the vessel's maximum emptying rate, in Sensor Units per minute.

3.6. Echo Information (ECHO INFO)

3.6.1. Level Transducer Block (TB VALUES) (for diagnostic purposes)

The output from the Level Transducer Block can be called the Primary Value (or Secondary Value). When it becomes the input to the AIFB, it is called the Process Variable.

3.6.1.1. Sensor Value (PV)

The default value for level (in level units).

Open the menu **View – Display**, and select the tab **Measured Value (Secondary Values)**.

3.6.1.2. Secondary Value 1 (SV1)

Equivalent value to PV (level).

3.6.1.3. Secondary Value 2 (SV2)

The value for distance (in sensor units).

Open the menu **View – Display**, and select the tab **Measured Value (Secondary Values)** and see Sensor Value.

3.6.2. Echo Quality (ECHO QUAL)

3.6.2.1. Echo Confidence Long (ECHO CON L)

Measures echo reliability. It displays the echo confidence of the measurement echo from the last shot. Confidence Threshold defines the minimum criterion for echo confidence.

Values (read only)	0 to 99	
	----	Shot not used
Related Parameters	Confidence Threshold	

Open the menu **View – Echo Profile**.

3.6.2.2. Echo Strength (STRENGTH)

Displays the absolute strength of the echo selected as the measurement echo.

Values (read only)	–20 to 99
---------------------------	------------------

Open the menu **View – Echo Profile**.

4. Output

4.1. Analog Input Function Block 1 (AIFB 1)

Static Revision No. (PROFIBUS PA only)

The revision level of the static data associated with Analog Input Function Block 1. The Static Revision No. is updated whenever a standard profile configuration parameter is changed.

4.1.1. Target Mode (TARGET MDE)

Used to request an operating mode from the Function Block.

Values		OS	Out of Service
		MAN	Manual Mode
	*	AUTO	Automatic Mode

In SIMATIC PDM (PROFIBUS PA only) open the menu **Device – Simulation**, and select the appropriate function block menu. Select the tab **Simulation (Output)** and see Target Mode.

4.1.2. Unit

Engineering unit to be displayed with the output value.

Options	percent	%
	user-defined	TEXT
	linear	M, CM, MM, FT, IN
default: M		

4.1.3. Filter Time Constant (FILT TIME)

The time constant for the damping filter. The engineering unit is always in seconds. (This is an exponential filter: when a change occurs at the input, the output will be at 63.2% of the change in one time constant, and will be at full change after 5 time constants.)

Values	Range: 0 to 300 s
	Default: 10 s

4.1.4. Function (CHANNEL)

Used to select between the different level block outputs: Level, or Distance. (See **Level Transducer Block function groups** on page 132 for an illustration.)

Options	PV	Primary Value - Level
	SV1	Secondary Value 1 - Level
	SV2	Secondary Value 2 - Distance (value in sensor units)

4.1.5. Batch Information (BATCH) (PROFIBUS PA only)

These 4 parameters are intended to be used in Batch Applications conforming to IEC 61512 Part 1 (ISA S88). Other applications do not require these values, which are only stored in the Function Block.

4.1.5.1. Batch ID

Identifies a certain batch to allow assignment of equipment-related information (for example faults, alarms) to the batch.

Values	Range: 0 to 4294967295
	Default: 0

4.1.5.2. Batch Unit

Identifies the active Control Recipe Unit Procedure or the related Unit (for example, reactor, centrifuge, drier).

Values	Range: 0 to 65535
	Default: 0

4.1.5.3. Batch Operation (BATCH OP.)

Identifies the active Control Recipe Operation.

Values	Range: 0 to 65535
	Default: 0

4.1.5.4. Batch Phase (BATCH PH)

Identifies the active Control Recipe Phase.

Values	Range: 0 to 65535
	Default: 0

4.1.6. Process Value Scale (PR VAL SCL)

4.1.6.1. Lower Value (LOWR VALUE)

Defines the operational lower range value of the input value (Process Value Scale) in engineering units. Process Value Scale normalizes the input value to a customer-defined range.

Values	Range: -999999 to 999999 m
	Default: 0 m

4.1.6.2. Upper Value (UPPR VALUE)

Defines the operational upper range value of the input value (Process Value Scale) in engineering units. Process Value Scale normalizes the input value to a customer-defined range.

Values	Range: -999999 to 999999 m
	Default: 70 m

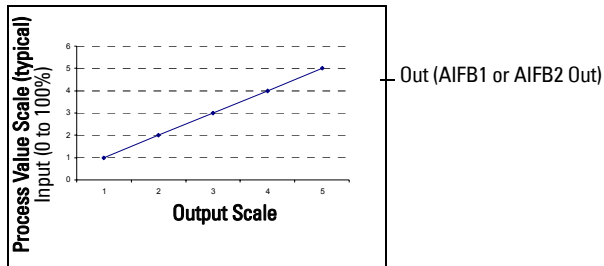

4.1.7. Output scale (OUT SCALE)

Scales the Process Variable. The function block parameter OUT SCALE contains the values of the lower limit and upper limit effective range.

4.1.7.1. Lower Value (LOWR VALUE)

Defines the operational lower range value of the output value in engineering units.

Values	Range: -999999 to 999999 m
	Default: 0 m

4.1.7.2. Upper Value (UPPR VALUE)

Defines the operational upper range value of the output value in engineering units.

Values	Range: -999999 to 999999 m
	Default: 70 m

4.1.8. Output Limits (OUT. LIM.)**4.1.8.1. Lower Limit Alarm (LO ALARM)**

The setting for the lower alarm limit in engineering units.

Values	Range: -999 to 999 m
	Default: -999 m

4.1.8.2. Lower Limit Warning (LO WARN) (PROFIBUS PA only)

The setting for the lower warning limit in engineering units.

Values	Range: -999 to 999 m
	Default: -999 m

4.1.8.3. Upper Limit Warning (UP WARN) (PROFIBUS PA only)

The setting for the upper warning limit in engineering units.

Values	Range: -999 to 999 m
	Default: 999 m

4.1.8.4. Upper Limit Alarm (UP ALARM)

The setting for the upper alarm limit in engineering units.

Values	Range: -999 to 999 m
	Default: 999 m

4.1.8.5. Limit Hysteresis (LIMIT HYS.)

Hysteresis is used to adjust the sensitivity of the trigger for alarm messages. It is used to compensate when a process variable fluctuates around the same value as a limit. A high level alarm occurs when a value exceeds an upper limit. The alarm's status remains true until the value drops below the limit minus the alarm hysteresis. The directions are reversed for low limit detection.

Enter a value for the hysteresis here, to be used for all warnings and alarms. The units are the same as the output value scale.

Values	Range: -999999 to 999999 m
	Default: 0.5% of output scale (See <i>Output scale (OUT SCALE) 4.1.7.</i> on page 71.)

4.1.8.6. Min Out

Min Out is a minimum peak indicator for the AIFB output values.

Open the menu **View – Peak Values** and select the appropriate Function Block tab. If necessary, click on the **Reset** button which will reset both the min. and max. values.

4.1.8.7. Max Out

Max Out is a maximum peak indicator for the AIFB output values.

Open the menu **View – Peak Values** and select the appropriate Function Block tab. If necessary, click on the **Reset** button which will reset both the min. and max. values.

4.1.9. Failsafe (PROFIBUS PA only)

4.1.9.1. Failsafe Mode (FS MODE)

Fail-safe Mode occurs if the status of the input value is bad, or if the device has been put into Fail-safe mode using Simulation. One of three options can be selected for the material level to be reported when the LOE timer expires.

	Handheld Programmer Options	SIMATIC PDM Options	Material Level to be reported
Options	FS VALUE		Substitute value Value used as output value when device goes into failsafe mode.
	LAST VAL	*	Last value Store last valid output value.
	USE BAD		Use bad value Calculated output value is incorrect.

4.1.9.2. Failsafe Value (FS VALUE)

*(Accessible in PDM only after **FS VALUE** is selected in Fail-safe Mode). User-defined default value for the OUT parameter, if sensor or sensor electronic fault is detected. Units are the same as the OUT value.*

Values	Range: -999999 to 999999
	Default: 0.000

4.1.A. Human Interface (INTERFACE)

4.1.A.1. Decimal Point (DECIMAL)

The number of digits to display after the decimal point. (The LCD is limited to displaying three decimal places.)

Out unit text

If the code list does not contain a desired unit for the OUT parameter, (see General Requirement) you can write the specific text in this parameter.

4.2. Analog Input Function Block 2 (AIFB 2)

(See *Analog Input Function Block 1 (AIFB 1)* 4.1. on page 68: the parameters for AIFB 2 are identical.)

4.3. mA Output (HART only)

The mA output is provided by Analog Input Function Block 1 (AIFB1). You can enter a user-defined mA value, either for simulation, or to perform a mA Trim.

To set these parameters via PDM, see *Simulate AO (Analog Output) (HART only)* on page 42 or *D/A (Digital/Analog) Trim (HART only)* on page 42.

4.3.1. Function

Allows you to set the mA output to one of three options including a user-defined value.

Handheld programmer values	AUTO	Uses the current measured value.
	FIXED	The current can be set by the HART master only. HART default is 4 mA.
	MANUAL	Uses a user-defined value input in 4.3.3. <i>Man Value</i> .

To set the mA output via PDM, open the menu **Device – Simulate AO**.

4.3.2. Out value

A mA value derived from the ratio of current level to the range between Lower Value (LOWR VALUE) and Upper Value (UPPR VALUE).

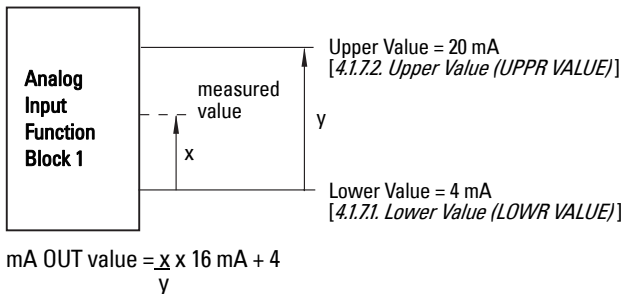

4.3.3. Man Value

A user-defined mA value which can be used either for simulation, or to do a digital/analog trim.

Values	Range: 3.5 to 22.6 mA
---------------	-----------------------

To set the mA Output via PDM, open the menu **Device – Simulate AO** and select an option.

4.3.4. mA Min Limit (MIN LIM)

The mA value to correspond with 4.1.7.1. Lower Value (LOWR VALUE).

Values	Range: 3.5 to 20.5 mA
	Default: 3.8 mA

4.3.5. mA Max Limit (MAX LIM)

The mA value to correspond with 4.1.7.2. Upper Value (UPPR VALUE).

Values	Range: 3.5 to 20.5 mA
	Default: 20.5 mA

4.3.6. Failsafe Mode (FS MODE)

The mA value to be output in the event of a fault or failure.

Options	MA HOLD	*	Level remains at last reading.
	MA SET		User-defined value set in 4.3.7. Failsafe Value (FS VALUE)
	MA HIGH		Use Max Limit as material level.
	MA LOW		Use Min Limit as material level.

4.3.7. Failsafe Value (FS VALUE)

A user-defined mA value to be reported when the Fail-safe timer expires.

Values	Range: 3.5 to 20.5 mA
	Default: 3.5 mA

4.3.8. 4 mA Trim (4MA TRIM)

Calibrates the 4 mA output.

Values	Range: 2.0 to 6.0 mA
Related parameters	<i>4.3.1. Function</i> <i>A mA value derived from the ratio of current level to the range between Lower Value (LOWR VALUE) and Upper Value (UPPR VALUE).</i>

- Set *4.3.1. Function* to MANUAL mode.
- Set *4.3.3. Man Value* to 4 mA.
- Attach a calibrated meter and check the output at the terminals. Record the remote reading in mA.
- Enter the recorded value in *4.3.8. 4 mA Trim (4MA TRIM)*.
- Restore *4.3.1. Function* to its previous setting.
- Confirm that the mA output is as expected.

4.3.9. 20 mA Trim (20MA TRIM)

Calibrates the 20 mA output.

Values	Range: 18 to 24 mA
Related parameters	<i>4.3.1. Function</i> <i>A mA value derived from the ratio of current level to the range between Lower Value (LOWR VALUE) and Upper Value (UPPR VALUE).</i>

- Set *4.3.1. Function* to MANUAL mode.
- Set *4.3.3. Man Value* to 20 mA.
- Attach a calibrated meter and check the output at the terminals. Record the remote reading in mA.
- Enter the recorded value in *4.3.9. 20 mA Trim (20MA TRIM)*.
- Restore *4.3.1. Function* to its previous setting.
- Confirm that the mA output is as expected.

4.4. Relay Configuration (RLY CONFIG) (HART only)

4.4.1. Relay AIFB (AIFB)

Select AIFB 1 or AIFB 2.

Options	1	AIFB 1
	2	AIFB 2

4.4.2. Relay Function (FUNCTION)

Handheld programmer Options	DISABLED	*	Relay is disabled and will not trigger
	MANUAL		Relay state can be changed (using parameter 4.4.4. Relay State (STATE)).
	LO ALM		Relay triggers when corresponding AIFB goes below low alarm
	HI ALM		Relay triggers when corresponding AIFB goes above high alarm
	ANY ALARM		Relay triggers when corresponding AIFB goes below low alarm or above high alarm
	FAILSAFE		Relay triggers when corresponding AIFB goes to failsafe mode

4.4.3. Relay NO/NC (NC/NO)

Handheld programmer Options	NO	*	Normally Open
	NC		Normally Closed

4.4.4. Relay State (STATE)

Handheld programmer Options	OFF	*	Relay de-energized
	ON		Relay energized

6. Maintenance Settings (MAINT SET)

Use these parameters to set up schedules for calibration and maintenance. The device will track itself based on operating hours, instead of a calendar-based schedule, and will monitor its predicted lifetime.

The maintenance warnings and alarms are communicated to the end user through either the status or condensed status bytes. This information can be integrated into any Asset Management system. For optimal use, we recommend that you use SIMATIC PCS7 Asset Management Software in conjunction with SIMATIC PDM.

6.1. Remaining Device Lifetime (DVC REMLIF)

Note: Performing a reset to Factory Defaults will reset all Maintenance parameters to their factory defaults.

The Remaining Device/Sensor Lifetime parameters set up schedules for calibration and maintenance.

To access these parameters via SIMATIC PDM open the menu **Device – Maintenance** and select the **Remaining Device Lifetime** tab.

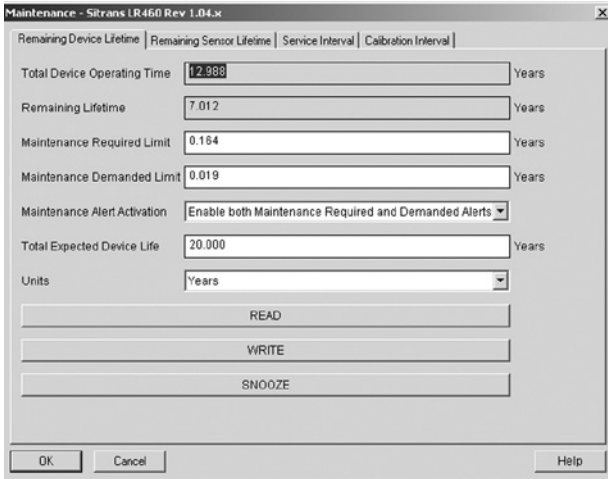

6.1.1. Total Device Operating Time (DVC OP TIM)

Read only. Displays the amount of time the device has been operating.

6.1.2. Remaining Lifetime (RETLIFE)

Read only. The sum of Total Expected Device Life less Total Device Operating Time.

6.1.3. Maintenance Required Limit (REQ LIMIT)¹

If the Total Expected Device Life less Total Device Operating Time is equal to or less than this limit, a Maintenance Required status is generated.

Values	Range: 0 to 20 years
	Default: 0.164 years

To modify the value via SIMATIC PDM:

- Modify limit values as required.
- See **Maintenance Alert Activation (ACTIVATION) (6.1.5.)** to set Alert Activation options.

¹ Data for this parameter must be entered in seconds on the device.

6.1.4. Maintenance Demanded Limit (DEM LIMIT)¹

If the Total Expected Device Life less Total Device Operating Time is equal to or less than this limit, a Maintenance Demanded status is generated.

Values	Range: 0 to 20 years
	Default: 0.019 years

To modify the value via SIMATIC PDM:

- Modify limit values as required.
- See **Maintenance Alert Activation (ACTIVATION) (6.1.5.)** to set Alert Activation options.

6.1.5. Maintenance Alert Activation (ACTIVATION)

Select limits to be activated.

Values	REQ LIMIT	Enable Maintenance Required Alert
	DEM LIMIT	Enable Maintenance Demanded Alert
	REQ & DEM	Enable both Maintenance Required and Demanded Alerts
	* OFF	Off

To enable or disable Maintenance Alert Activation via SIMATIC PDM:

- First set the limit values in **Maintenance Required Limit (REQ LIMIT) (6.1.3.)/ Maintenance Demanded Limit (DEM LIMIT) (6.1.4.)**.
- Select the desired Alert Activation option.

6.1.6. Total Expected Device Life (EXP LIFE)¹

The device tries to predict its overall lifetime. The factory default can be reset by the user.

Values	Range: 0 to 20 years
	Default: 10.00 years

To modify the value via SIMATIC PDM:

- Open the menu **Device – Maintenance** and click on **Remaining Device Lifetime**.
- Enter the desired value (or click **Snooze** to add a year to the current value), then click on **Write** to accept the change.
- Click on **Read** to view the effect of the modification.

Units

Allows you to set desired units using SIMATIC PDM.

Options	Hours
	Days
	Years

¹ Data for this parameter must be entered in seconds on the device.

6.1.7. Status (MAINT STAT)

Read only. Displays the status of the Maintenance Alerts.

Options (read only)	NONE	None
	MAINT REQ	Maintenance Required
	MAINT DEM	Maintenance Demanded

To view via SIMATIC PDM open the menu **View - Device Status** (PROFIBUS PA) or **View – Status** (HART), click on the **Maintenance** tab, and check the **Device Lifetime Status** window.

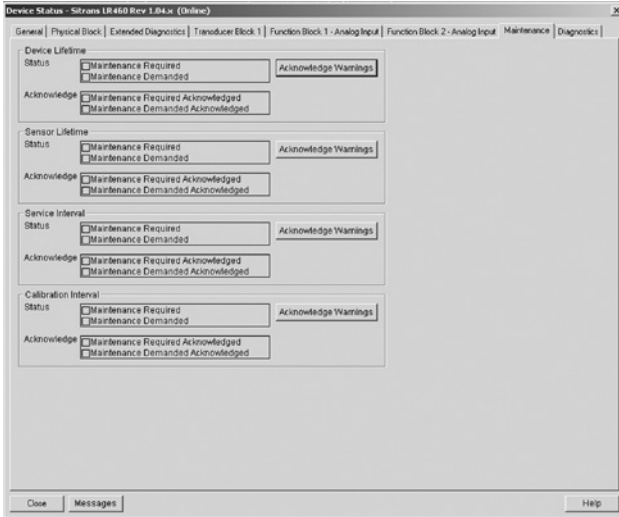

* only Status, Maintenance, and Diagnostics tabs appear with HART device.

6.1.8. Acknowledge (ACK STATUS)

Read only. Displays the status of the Maintenance Alerts that have been acknowledged.

Options (read only)	NONE	None
	ACK M REQ	Maintenance Required Acknowledged
	ACK M DEM	Maintenance Demanded Acknowledged
	BOTH	Both Maintenance Required and Demanded Acknowledged

To view via SIMATIC PDM open the menu **View - Device Status** (PROFIBUS PA) or **View – Status** (HART), click on the **Maintenance** tab, and check the **Device Lifetime Status** window.

6.1.9. Acknowledge Warnings (ACK)

Allows you to acknowledge either a Maintenance Required or a Maintenance Demanded alert.

To acknowledge an alert via SIMATIC PDM:

- a. Open the menu **View - Device Status** (PROFIBUS PA) or **View – Status** (HART), and click on the **Maintenance** tab.
- b. In the **Device Lifetime** window click on **Acknowledge Warnings**.

Options (read only)	IGNORE
	ACK WARNING

6.2. Remaining Sensor Lifetime (SNS REMLIF)

The device monitors the predicted lifetime of the sensor (the components exposed to the vessel environment).

*To access these values via SIMATIC PDM, open the menu **Device - Maintenance** and select the **Remaining Sensor Lifetime** tab.*

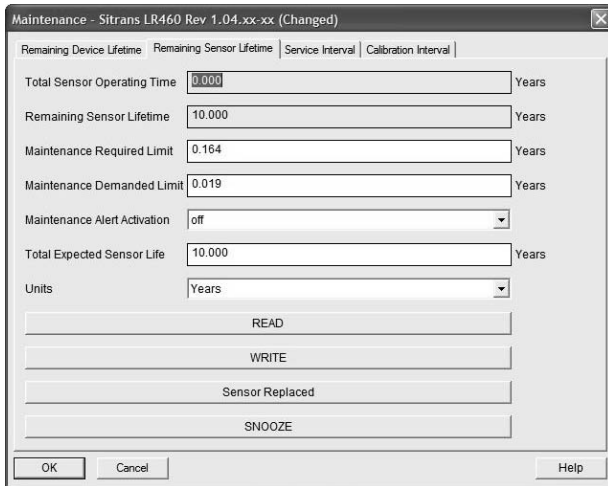

6.2.1. Total Sensor Operating Time (SNS OP TIM)

Read only. Displays the amount of time the sensor has been operating.

Can be set to zero via the handheld programmer (after performing a service).

6.2.2. Remaining Sensor Lifetime (RESTLIFE)

Read only. The sum of Total Expected Sensor Life less Total Sensor Operating Time.

6.2.3. Maintenance Required Limit (REQ LIMIT)¹

If the Total Expected Sensor Life less Total Sensor Operating Time is equal to or less than this limit, a Maintenance Required status is generated.

Values	Range: 0 to 20 years
	Default: 0.164 years

To modify the value via SIMATIC PDM:

- a. Modify limit values as required.
- b. Enable **Maintenance Alert Activation (ACTIVATION) (6.2.5.)** to set the Alert Activation options.

6.2.4. Maintenance Demanded Limit (DEM LIMIT)¹

If the Total Expected Sensor Life less Total Sensor Operating Time is equal to or less than this limit, a Maintenance Demanded status is generated.

Values	Range: 0 to 20 years
	Default: 0.019 years

To modify the value via SIMATIC PDM:

- a. Modify limit values as required.
- b. Enable **Maintenance Alert Activation (ACTIVATION) (6.2.5.)** to set the Alert Activation options.

6.2.5. Maintenance Alert Activation (ACTIVATION)

Select limits to be activated.

Values	REQ LIMIT	Enable Maintenance Required Alert
	DEM LIMIT	Enable Maintenance Demanded Alert
	REQ & DEM	Enable both Maintenance Required and Demanded Alerts
	* OFF	Off

To enable or disable Maintenance Alert Activation via SIMATIC PDM:

- a. First set the limit values in **Maintenance Required Limit (6.2.3)/ Maintenance Demanded Limit (6.2.4)**.
- b. Select the desired Alert Activation option.
- c. Click on **Write** to accept the change.

¹ Data for this parameter must be entered in seconds on the device.

6.2.6. Total Expected Sensor Life (EXP LIFE)¹

The device tries to predict its overall lifetime. You can reset the factory default.

Values	Range: 0 to 20 years
	Default: 10.00 years

To modify the value via SIMATIC PDM:

- Open the menu **Device – Maintenance** and click on **Remaining Sensor Lifetime**.
- Enter the desired value (or click on **Snooze** to add a year to the current value) then click on **Write** to accept the change.
- Click on **Read** to view the effect of the modification.

Units

Allows you to set desired units using SIMATIC PDM.

Options	Hours
	Days
	Years

6.2.7. Status (MAINT STAT)

Read only. Displays the status of the Maintenance Alerts.

Options (read only)	NONE	None
	MAINT REQ	Maintenance Required
	MAINT DEM	Maintenance Demanded

¹ Data for this parameter must be entered in seconds on the device.

To view via SIMATIC PDM open the menu **View - Device Status** (PROFIBUS PA) or **View – Status** (HART), click on the **Maintenance** tab, and check the **Sensor Lifetime Status** window.

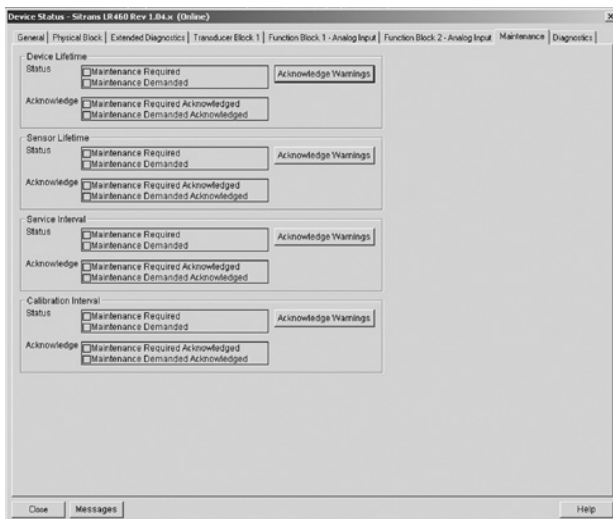

* only Status, Maintenance, and Diagnostics tabs appear with HART device.

6.2.8. Acknowledge (ACK STATUS)

Read only. Displays the status of the Maintenance Alerts that have been acknowledged.

Options (read only)	NONE	None
	ACK M REQ	Maintenance Required Acknowledged
	ACK M DEM	Maintenance Demanded Acknowledged
	BOTH	Both Maintenance Required and Demanded Acknowledged

To view via SIMATIC PDM open the menu **View - Device Status** (PROFIBUS PA) or **View – Status** (HART), and click on the **Maintenance** tab and check the **Sensor Lifetime Status** window.

6.2.9. Acknowledge Warnings (ACK)

Allows you to acknowledge either a Maintenance Required or a Maintenance Demanded alert.

To acknowledge an alert via SIMATIC PDM:

- Open the menu **View - Device Status** (PROFIBUS PA) or **View – Status** (HART), and click on the **Maintenance** tab.
- In the **Sensor Lifetime** window click on **Acknowledge Warnings**.

Options (read only)	IGNORE
	ACK WARNING

6.3. Service Interval (SERVICE)

Allows for scheduling of service inspections.

To access these parameters via SIMATIC PDM, open the menu **Device – Maintenance** and click on the **Service Interval** tab.

6.3.1. Time Lapsed From Last Service (LAST SVC)

Read only. Time elapsed since device was last serviced.

Can be reset to zero via the handheld programmer (after performing a service).

6.3.2. Maintenance Required Limit (REQ LIMIT)¹

If the Total Service Interval less the Time Lapsed from Last Service is equal to or less than this limit, a Maintenance Required status is generated.

Values	Range: 0 to 20 years
	Default: 0.164 years

6.3.3. Maintenance Demanded Limit (DEM LIMIT)¹

If the Total Service Interval less the Time Lapsed from Last Service is equal to or less than this limit, a Maintenance Demanded status is generated.

Values	Range: 0 to 20 years
	Default: 0.019 years

6.3.4. Maintenance Alert Activation (ACTIVATION)

Select limits to be activated.

Options	*	TIMER OFF	Timer Off
		EN NO LIMITS	Timer On, No Limit Checking
		EN LIMIT 1	Timer On, Maintenance Required
		EN LIM 1&2	Timer On, Maintenance Required and Demanded Enabled
		EN LIMIT 2	Timer On, Maintenance Demanded Enabled

6.3.5. Total Service Interval (INTERVAL)¹

Set time between scheduled service inspections.

Values	Range: 0 to 20 years
	Default: 1.0 year

Units

Allows you to set desired units using SIMATIC PDM.

Options	Hours
	Days
	Years

¹. Data for this parameter must be entered in seconds on the device.

6.3.6. Status (MAINT STAT)

Read only. Displays the status of the Maintenance Alerts.

Options (read only)	NONE	None
	MAINT REQ	Maintenance Required
	MAINT DEM	Maintenance Demanded

In SIMATIC PDM, open the menu **View - Device Status** (PROFIBUS PA) or **View – Status** (HART), click on the **Maintenance** tab and check the **Service Interval** window.

6.3.7. Acknowledge (ACK STATUS)

Read only. Displays the status of the Maintenance Alerts that have been acknowledged.

Options (read only)	NONE	None
	ACK M REQ	Maintenance Required Acknowledged
	ACK M DEM	Maintenance Demanded Acknowledged
	BOTH	Both Maintenance Required and Demanded Acknowledged

In SIMATIC PDM, open the menu **View - Device Status** (PROFIBUS PA) or **View – Status** (HART), click on the **Maintenance** tab and check the **Service Interval** window.

6.3.8. Acknowledge Warnings (ACK)

Allows you to acknowledge either a Maintenance Required or a Maintenance Demanded alert.

In SIMATIC PDM:

- a. Open the menu **View - Device Status** (PROFIBUS PA) or **View – Status** (HART), and click on the **Maintenance** tab.
- b. In the **Service Interval** window, click on **Acknowledge Warnings**.

Options (read only)	IGNORE
	ACK WARNING

6.4. Calibration Interval (CAL)

Allows you to schedule calibration.

To access these parameters via SIMATIC PDM, open the menu **Device – Maintenance** and click on the **Calibration Interval** tab.

6.4.1. Time Lapsed From Last Calibration (LAST CAL)

Read only: time elapsed since device was last calibrated.

Can be reset to zero via the handheld programmer (after performing a service).

6.4.2. Maintenance Required Limit (REQ LIMIT)¹

If the Total Calibration Interval less the Time Lapsed from Last Calibration is equal to or less than this limit, a Maintenance Required status is generated.

Values	Range: 0 to 20 years
	Default: 0.164 years

6.4.3. Maintenance Demanded Limit (DEM LIMIT)¹

If the Total Calibration Interval less the Time Lapsed from Last Calibration is equal to or less than this limit, a Maintenance Demanded status is generated.

Values	Range: 0 to 20 years
	Default: 0.019 years

6.4.4. Maintenance Alert Activation (ACTIVATION)

Select limits to be activated.

Options	*	TIMER OFF	Timer Off
		EN NO LIMITS	Timer On, No Limit Checking
		EN LIMIT 1	Timer On, Maintenance Required
		EN LIM 1&2	Timer On, Maintenance Required and Demanded Enabled
		EN LIMIT 2	Timer On, Maintenance Demanded Enabled

6.4.5. Total Calibration Interval (INTERVAL)¹

Set time between scheduled calibrations.

Values	Range: 0 to 20 years
	Default: 1.0 year

Units

Allows you to set desired units using SIMATIC PDM.

Options	Hours
	Days
	Years

6.4.6. Status (MAINT STAT)

Read only; Displays the status of the Maintenance Alerts.

Options (read only)	NONE	None
	MAINT REQ	Maintenance Required
	MAINT DEM	Maintenance Demanded

¹. Data for this parameter must be entered in seconds on the device.

In SIMATIC PDM, open the menu **View - Device Status (PROFIBUS PA)** or **View – Status (HART)**, click on the **Maintenance** tab and check the **Calibration Interval** window.

6.4.7. Acknowledge (ACK STATUS)

Read only: displays the status of the Maintenance Alerts that have been acknowledged.

Options (read only)	NONE	None
	ACK M REQ	Maintenance Required Acknowledged
	ACK M DEM	Maintenance Demanded Acknowledged
	BOTH	Both Maintenance Required and Demanded Acknowledged

In SIMATIC PDM, open the menu **View - Device Status (PROFIBUS PA)** or **View – Status (HART)**, click on the **Maintenance** tab and check the **Calibration Interval** window.

6.4.8. Acknowledge Warnings (ACK)

Allows you to acknowledge either a Maintenance Required or a Maintenance Demanded alert.

In SIMATIC PDM:

- Open the menu **View - Device Status (PROFIBUS PA)** or **View – Status (HART)**, and click on the **Maintenance** tab.
- In the **Calibration Interval** window, click on **Acknowledge Warnings**.

Options (read only)	IGNORE
	ACK WARNING

7. Condensed Status Setup (COND SETUP) (PROFIBUS PA only)

This device conforms with PROFIBUS Profile for Process Control Devices version 3.01. Condensed Status was introduced in this version. The following sections allow the user to set the level of severity of the errors listed and to tailor a device response appropriate for your particular process.

7.1. Condensed Status Mode (COND STAT)

Options	*	NO	Disabled
		YES	Enabled

Select **Yes** or **No** to enable/disable Condensed Status Mode.

7.2. Features Supported (FEAT SUP) (Read only)

Features supported are:

- Condensed Diagnostics
- Extended Diagnostics
- Application Relationships

7.3. Features Enabled (FEAT EN) (Read only)

Lists those features that have been enabled.

7.4. Event Switch (EVNT SWTCH)

7.4.1. Event Index (EVNT INDEX)

The numeric component of the Event Code for a Condensed Status event. For example, the Event Code (status designation) for Loss of Echo (LOE) is S0: the Event Index is 0.

Event Index	Event Code	Event Description
0	S0	Loss of Echo
10	S10	LTB (Level Transducer Block) Scale
11	S11	Internal Temp Sensor
12	S12	Internal Temp High
14	S14	AIFB1 PV Range
15	S15	AIFB2 PV Range
19	S19	DSP not ready
20	S20	Shaper not downloaded
21	S21	AFES not downloaded
28	S28	Memory RAM
29	S29	Memory EEPROM
30	S30	Memory EEPROM Flags
31	S31	Memory Flash
34	S34	Velocity Calibration
37	S37	Tech Module Hardware

7.4.2. Event Status (EVNT STAT)

Event Status allows you to assign one of the status options listed below, to any of the events listed in **Event Index (EVNT INDEX) (7.4.1.)**. This allows you to tailor a device response appropriate for your particular process.

Handheld programmer values		Event Status Options
GOOD		Good
G MAINT REQ		Good: maintenance required
G MAINT DEM		Good:maintenance demanded
U MAINT DEM		Uncertain: maintenance demanded
B MAINT ALM	*	Bad: maintenance alarm
U PROC REL		Uncertain: process related, no maintenance
B PROC REL		Bad: process related, no maintenance
B FUNC CHK		Bad: function check / local override
G FUNC CHK		Good: function check

To assign a status to a particular event via the handheld programmer:

- Go to **Condensed Status Mode (COND STAT) (7.1.)** and select **Yes** to enable Condensed Mode.
- In **Event Index (EVNT INDEX) (7.4.1.)** enter the event index number corresponding to a particular event.
- In **Event Status (EVNT STAT) (7.4.2.)** enter the equivalent value of the appropriate Event Status from the table above.

To assign a status to a particular event via SIMATIC PDM:

- Go to Condensed Status Setup, click on it and select **Yes** to enable **Condensed Status Mode (COND STAT) (7.1.)**.
- From **Condensed Status Setup>Condensed Status**, select the **Status** line for a desired event.
- From the pull-down menu in the Value field, click on the desired value.

7.4.3. Event Diagnosis (EVNT DIAG)

*Allows you to assign one of the diagnostic options listed below to any of the events listed in **Event Index (EVNT INDEX) (7.4.1.)**. This allows you to tailor a device response appropriate for your particular process.*

Handheld programmer values		Event Diagnosis Options
GOOD		Status OK
MAINT REQ		Maintenance required
MAINT DEM		Maintenance demanded
MAINT ALM	*	Maintenance alarm
INV PR COND		Invalid process condition
FUNC CHECK		Function check or simulation

To assign an Event Diagnosis via the handheld programmer:

- Go to **Condensed Status Mode (COND STAT) (7.1.)** and select **Yes** to enable Condensed Mode.
- Go to **Event Index (EVNT INDEX) (7.4.1.)** and enter the event index number corresponding to a particular event.
- In **Event Diagnosis (EVNT DIAG) (7.4.3.)** enter the equivalent value of the appropriate Event Diagnosis from the table above.

To assign an Event Diagnosis via SIMATIC PDM:

- Go to Condensed Status Setup, click on it and select **Yes** to enable **Condensed Status Mode (COND STAT) (7.1.)**.
- From **Condensed Status Setup>Condensed Status**, select the **Diagnosis** line for a desired event.
- From the pull-down menu, choose the desired diagnosis option and press **Enter**.

Appendix A: Technical Reference

Principles of Operation

SITRANS LR460 is a long range FMCW (Frequency Modulated Continuous Wave) radar transmitter. Radar level measurement uses the time of flight principle to determine distance to a material surface.

FMCW radar transmits a continuous wave. The frequency of the wave is constantly increasing: this is known as the sweep. By the time the first part of the wave has been reflected off the target and returned to the device, the part of the wave that is just being emitted is at a higher frequency. The difference in frequency between the transmitted and received signals is proportional to time of flight.

Electromagnetic wave propagation is virtually unaffected by temperature or pressure changes, or by changes in the vapor or dust levels inside a vessel.

SITRANS LR460 consists of an enclosed electronic component coupled to an antenna and process connection. The electronic component generates an electromagnetic signal from 24.2 GHz to 25.2 GHz that is directed to the antenna.

The signal is emitted from the antenna, and the reflected echoes are digitally converted to an echo profile. The profile is analyzed to determine the distance from the material surface to the reference point on the instrument. This distance is used as a basis for the display of material level and output.

Measurement Response

The measurement response (response rate) limits the maximum rate at which the display and output respond to changes in the measurement. Once the real process fill/empty rate (m/s) is established, a response rate can be selected that is slightly higher than the application rate. The response rate automatically adjusts the filters that affect the output response rate.

There are three preset options: slow, medium, and fast.

Related Parameters	Response Rate	LOE Timer (minutes)	Fill Rate	Empty Rate
Values	* slow	100	0.1 m/minute	0.1 m/minute
	medium	10	1 m/minute	1 m/minute
	fast	1	10 m/minute	10 m/minute

If none of the preset options is satisfactory, the filters can be adjusted individually.

Echo Processing

Profile monitoring via SIMATIC PDM

To view an echo profile open the menu **View – Echo Profile**.

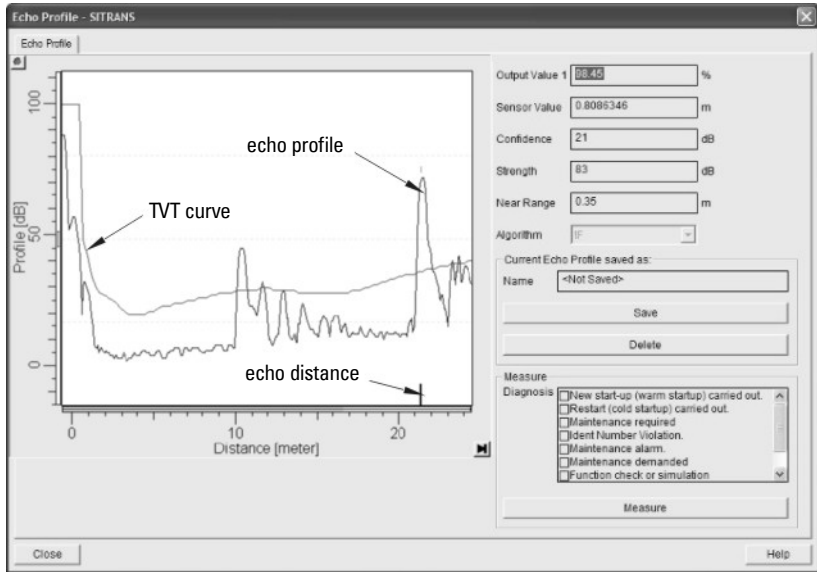

You will see the echo profile, the Time Varying Threshold (TVT), and a vertical line indicating the distance from the sensor to the echo selected.

Echo strength is indicated on the Profile (dB) vertical axis. The distance shown on the horizontal axis is the distance from the sensor to the target.

Time Varying Threshold (TVT)

The TVT is a threshold curve used to detect the presence of significant echoes. See *Auto False-Echo Suppression* on page 93 for more detail.

Echo selection

The device considers all peaks that are above the TVT as a potential good echo.

Each peak gets a rating based on its strength, area, height above the TVT, and other parameters. The true echo is selected based on the setting for *Algorithm* on page 59.

False Echoes

False echoes can appear during the receive cycle. They can be caused by interference with the emission cone, or by internal impediments like a ladder rung, and are usually indicated by an incorrect high level reading.

Beam angle at -3dB reference

Make allowance for the beam spreading, to avoid interference with the emission cone.

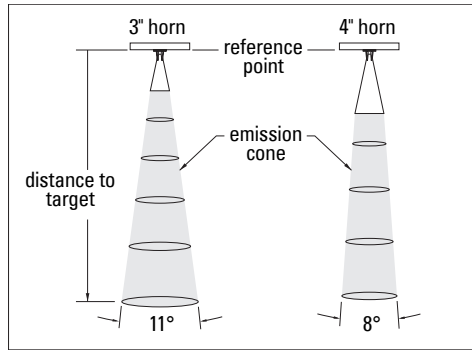

Polarization reference point

You can rotate the device to minimize false echoes. See *Polarization Reference Point* on page 15 for details.

Auto False-Echo Suppression

Note: If possible, rotate the instrument before using Auto False-Echo Suppression, to lower the amplitude of false echoes.

The TVT adjustment parameters allow you to manipulate the TVT (Time Varying Threshold), so that SITRANS LR460 will ignore false echoes.

The default TVT hovers above the echo profile, and effectively screens out small false echoes. But if an obstruction is causing a large echo before the material level echo, that echo will rise above the default TVT.

1. Set Auto False-Echo Suppression to **Learn**. The instrument learns the echo profile at that moment¹. The new TVT follows the echo profile, so that nothing rises above it.
2. Set Auto False Echo Suppression Distance so that the learned TVT will be used in the area of the false echoes, which will not rise above it. From that point on the default TVT will be used. The material level echo rises above this, and is selected as the true echo.

See page 65 for examples of the echo profile before and after using Auto False-Echo Suppression.

¹ Set **Auto False-Echo Suppression** to **Learn** when the material level is substantially lower than process full level (ideally when the vessel is empty or almost empty).

Near Range (Blanking)

Note: Auto False-Echo Suppression is generally recommended in preference to using Near Range.

Near Range allows you to set a distance in front of the antenna, within which any echoes will be ignored.

Echo confidence

Echo confidence is an internally generated numeric rating given to an echo based on its relative strength, area, and height.

Loss of Echo (LOE)

A loss of echo (LOE) occurs when the calculated measurement is judged to be unreliable because the echo confidence value has dropped below the echo confidence threshold. The LOE timer starts running, and if the LOE condition persists beyond ten minutes (the time limit set by the LOE timer) the Unreliable Echo indicator replaces the Reliable Echo indicator.

Reliable Echo indicator  Unreliable Echo indicator 

While LOE is pending the **x** flashes, alternating with the two horizontal bars. When LOE becomes active, the **x** becomes solid and the auxiliary display shows fault code **S:0**.

Upon receiving a reliable echo, the loss of echo condition is aborted, the Reliable Echo indicator reappears, and the reading returns to the current level.

LOE Timer

The LOE timer determines the time (in minutes) to elapse after the last valid reading before Fail-safe mode is activated. When the LOE timer expires, the material level to be reported is determined by Fail-safe Mode.

Fail-safe Mode

Fail-safe mode defines the reaction of the device if a Fail-safe condition is detected, so that the process will be put into a safe state in the event of a fault or failure. The particular application determines whether a high or low level is safe.

The Fail-safe condition may be triggered by a loss of echo, a bad configuration, or certain device faults. You can select one of three possible values to be reported when a Fail-safe mode occurs:

- User-defined default value (Fail-safe value) used as output value.
- Store last valid output value.
- Calculated output value is incorrect.

Fail-safe value

The user-defined Fail-safe value allows you to enter the safest output value for your application.

Maximum Process Temperature Chart

! WARNING: Internal temperature must not exceed +85 °C (+185 °F).

Note: The chart below is for guidance only.

To check maximum and minimum temperatures recorded via SIMATIC PDM, open the menu **View – Peak Values**, and click on the temperature tab. The peak temperatures indicate the extent of change required to the installation in order to provide a reliable thermal-operating zone for SITRANS LR460.

- For example, if the internal temperature exceeds the maximum allowable limit, a sun shield or a longer nozzle may be required.

To check temperature peaks via the handheld programmer, press **9** (#6) to view internal device temperature on the LCD secondary display.

To check process minimum/maximum temperatures via the handheld programmer:

- Press **Mode** to open PROGRAM mode, and key in **34** for Quick Access, or use ARROW keys to navigate to **Input–Meas Lim**. Press **RIGHT Arrow**.
- Press **DOWN Arrow** until values for **Proc T Min** and **Proc T Max** are displayed.

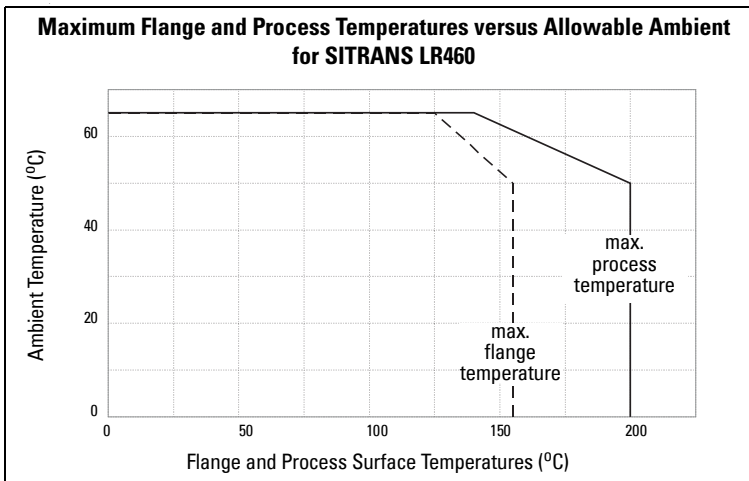

- The chart above is provided for guidance only.
- It does not represent every possible process connection arrangement.
- It does not take into consideration heating from direct sunshine exposure.

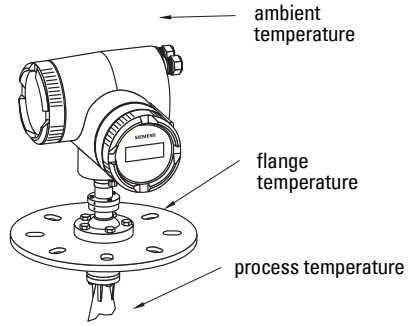

Where the chart does not apply, please use your own judgement regarding the use of SITRANS LR460.

Notes

Appendix B: Troubleshooting

1. Check the following:
 - There is power at the instrument.
 - The LCD shows the relevant data.
 - Check whether any fault codes are being displayed (see *General Fault Codes* on page 102 for a detailed list).
 - The device can be programmed using the handheld programmer.
2. Verify that the wiring connections are correct.
3. Check the HART (or PROFIBUS) address and make sure all devices are at unique HART (or PROFIBUS) addresses.
4. If you continue to experience problems, go to our website at: www.siemens.com/processautomation, and check the FAQs for SITRANS LR460, or contact your Siemens Milltronics representative.

Troubleshooting LR460		
Symptom	Possible cause	Remedy
LR460 reads 100% continuously	False echo near antenna.	Move LR460 to better location. Rotate LR460 to change polarization field. Shorten vessel nozzle to allow antenna to project into vessel. Aim LR460 away from false echo.
	Antenna buildup.	Clean antenna. Install PTFE dust cover. Use Air Purge option.
Reading is frozen	Antenna buildup.	Clean antenna. Install PTFE dust cover. Use Air Purge option.
	Low dK and low bulk density material.	Lower echo confidence threshold.

Troubleshooting LR460 (cont'd)

Symptom	Possible cause	Remedy
Reads empty when vessel not empty.	Reads vessel bottom through low dK material.	Increase TVT manually at vessel bottom region. Set Far Range to a lower value. Lower TVT hover level.
Reading fluctuates.	Due to solids' sloped surfaces some fluctuation is normal.	Reduce response rate. Decrease fill/empty parameter values. Increase filter time constant in AIFB.
Echo has double peak/is split		Increase Echo Reform.
Reading is too slow and lags behind actual level change.		Increase response rate. Turn off Window tracking. Change fill/empty rate parameter values. Increase filter time constant in AIFB.
Device cannot be programmed via the handheld programmer		Make sure local operation is enabled. See <i>Local Operation Enable</i> on page 54. Also make sure that Write Locking is Off. See <i>Write Locking (LOCK)</i> on page 54.
You are unable to modify a parameter via remote communications		Make sure remote operation is enabled. See <i>Remote operation enable (REMLOCK)</i> on page 49. Also make sure that Write Locking is Off. See <i>Write Locking (LOCK)</i> on page 54.

Troubleshooting LR460 (cont'd)

Symptom	Possible cause	Remedy
The PLC value equals the display value, but does not correspond to actual material level.	<ul style="list-style-type: none">• scaling in AIFB1 is incorrect• High Calibration Point is incorrectly entered• the wrong echo is being selected	<ul style="list-style-type: none">• Adjust scaling in AIFB• Correct High Calibration Point setting
The PLC value is not equal to the displayed value (regardless of actual material level).	<ul style="list-style-type: none">• You may not be looking at the right spot in the PLC• You may have programmed scaling into the PLC, instead of leaving all scaling to be performed in the LR460.• The PLC may not be communicating with the LR460.	<ul style="list-style-type: none">• Check the network to verify that you are communicating.

General Fault Codes

Notes:

- In PROFIBUS PA these 6 bytes are returned through Extended Diagnosis.
- In HART these 6 bytes are returned by Command 48.
- Some faults cause the device to go to Fail-safe mode. These are indicated with an asterisk (*).

LCD display	Meaning	Corrective Action	Byte	Bit
S:0	* Loss of Echo (LOE) condition: the device was unable to get a measurement within the Fail-safe timer period. Possible causes: faulty installation, material buildup, and/or presence of foam.	Ensure installation details are correct. Ensure no material buildup. Adjust process conditions to minimize foaming. If problem persists, contact your local Siemens representative.	0	0
S:3	Device is nearing its lifetime limit according to the value set in Maintenance Required Limit.	Replacement is recommended.		3
S:4	Device is nearing its lifetime limit according to the value set in Maintenance Demanded Limit.	Replacement is recommended.		4
S:6	Sensor is nearing its lifetime limit according to the value set in Maintenance Required Limit.	Replacement is recommended.		6
S:7	Sensor is nearing its lifetime limit according to the value set in Maintenance Demanded Limit.	Replacement is recommended.		7
S:8	Service interval as defined in Maintenance Required Limit has expired.	Perform service.	1	0
S:9	Service interval as defined in Maintenance Demanded Limit has expired.	Perform service.		1

LCD display		Meaning (cont'd)	Corrective Action	Byte (cont'd)	Bit
S:10		Input parameters High Calibration Point and Low Calibration Point are the same.	Check calibration settings of device. Ensure settings for High Calibration Point and Low Calibration Point are different.	1	2
S:11		Internal temperature sensor failure.	Return the device to the factory.		3
S:12	*	Internal temperature of the device has exceeded specifications: it is operating outside its temperature range.	Lower the ambient temperature enough to cool the device. Fault code will persist until a manual reset is performed using PDM or the LCD interface.		4
S:14	*	Upper and lower input values (Process Value Scale) for AIFB1 are the same.	Check configuration for AIFB1. Ensure that Upper Value and Lower Value (Process Value Scale) are not the same.		6
S:15		Upper and lower input values (Process Value Scale) for AIFB2 are the same.	Check configuration for AIFB2. Ensure that Upper Value and Lower Value (Process Value Scale) are not the same.		7
S: 17		Calibration interval as defined in Maintenance Required Limit has expired.	Perform calibration.	2	1
S: 18		Calibration interval as defined in Maintenance Demanded Limit has expired.	Perform calibration.		2
S: 19		DSP could not be initialized	If fault persists, return device to manufacturer		3
S: 20		The TVT Shaper could not be recovered.	If fault persists, return device to manufacturer.		4
S: 21		The AFES profile could not be recovered.	If fault persists, return device to manufacturer.		5

LCD display	Meaning (cont'd)	Corrective Action	Byte (cont'd)	Bit
S:28	Internal device failure caused by a memory error.	Repair required: contact your local Siemens representative.	3	4
S:29	EEPROM damaged.	Repair required: contact your local Siemens representative.		5
S:30	EEPROM corrupt.	Reset power. If error persists, contact your local Siemens representative.		6
S:31	Flash error.	Repair required: contact your local Siemens representative.		7
S: 32	The IDENT number used in communications, and number selected by the Ident Number Selector do not correspond.	Ensure value of the Ident number selector is correct for the network configuration. If it is correct, the device needs to be re-parameterized by the PLC.	4	0
S:34	* Factory calibration for the device has been lost.	Repair required: contact your local Siemens representative.		2
S:37	* Unable to collect profile.	Repair required: contact your local Siemens representative.		5
S:51	<u>HART ONLY:</u> The mA calibration was not retrieved from EEPROM and is corrupt.	Perform a current trim to calibrate the 4 mA and 20 mA points.	14	3

Appendix C: Maintenance

SITRANS LR460 requires no maintenance or cleaning under normal operating conditions.

Under severe operating conditions, the antenna may require periodic cleaning. If cleaning becomes necessary:

- We recommend using high pressure air to clean the antenna.
- The inside of the horn can be scraped, but be very careful not to damage the small PTFE emitter inside the horn.

Unit Repair and Excluded Liability

All changes and repairs must be done by qualified personnel, and applicable safety regulations must be followed. Please note the following:

- The user is responsible for all changes and repairs made to the device.
- All new components must be provided by Siemens Milltronics Process Instruments Inc.
- Restrict repair to faulty components only.
- Do not re-use faulty components.
- Do not remove factory lock screw.
- Do not rotate upper wave guide with respect to housing or internal change may occur.

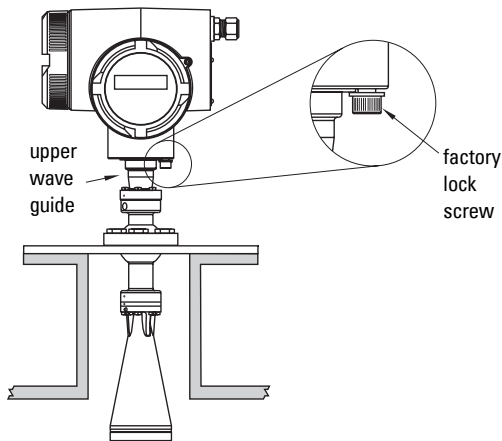

Notes:



Appendix D: Local Operation Interface

The LCD Display

Note: SITRANS LR460 continues to monitor In and Out values even when the device is in PROGRAM mode.

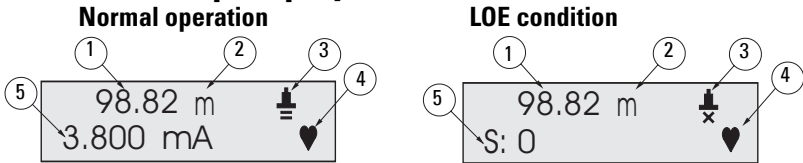
RUN mode (startup display)



- 1 – Primary display: level, space, or distance
- 2 – Units: for Primary Value (m, cm, mm, ft, in, or percent) if applicable
- 3 – Echo status indicator:
 - Reliable Echo:  visible during normal operation.
 - Unreliable Echo:  If LOE is pending¹ the **x** flashes, alternating with the two horizontal bars. When LOE becomes active, the **x** becomes solid and the auxiliary display shows fault code **S: 0**.
- 4 – Heartbeat: a small heart-shaped icon flashes on and off once per second.
- 5 – Auxiliary display²: distance, mA value (HART only), confidence, or temperature.

PROGRAM Mode Display

- 1 – Menu level
- 2 – Parameter name
- 3 – Edit Mode indicator/PROGRAM icon
- 4 – Value of current parameter

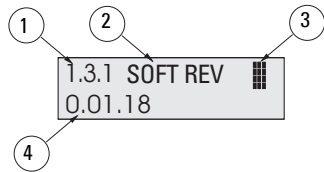





¹ See *LOE Timer* on page 94 for details.





² Appears in response to request via Siemens Milltronics handheld programmer

The handheld programmer

Notes:

- Local programming must be enabled, to allow changes (see *Local Operation Enable* on page 54).
- **CLEAR**  can be used to clear the field.
- Press **Right ARROW**  to open Edit mode: the PROGRAM icon flashes.
- Press **Right ARROW**  again to accept the value and cancel Edit mode: the final digit of the Menu number flashes (the Edit mode icon is not visible).
- For Quick Access to parameters via the handheld programmer, press Mode key  to activate PROGRAM mode, followed by Home key , then enter the menu number (see *LCD Menu Structure* on page 145 for details).



Hand-held programmer: key functions in RUN mode

Key	Function
	Updates mA value (HART version only)
	Updates internal enclosure temperature value and displays it in LCD auxiliary region.
	Updates echo confidence value and displays it in LCD auxiliary region.
	Updates measurement value and displays it in LCD auxiliary region.



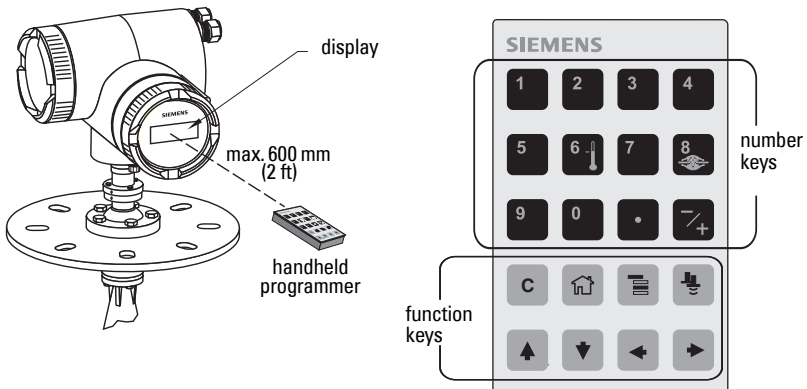



PROGRAMMING via the handheld programmer

To activate PROGRAM mode, point the handheld programmer at the display (from a maximum distance of 600 mm [2 ft.]), and press the Mode key .









- In Navigation mode the rightmost digit of the menu number flashes and the PROGRAM icon  is not visible.
- In Edit Mode the PROGRAM icon  appears and flashes: press a number key to enter parameter data.¹



Hand-held programmer: key functions in Navigation mode

Key	Name	When displaying:	Navigation Mode
	Up/down arrow	menu or item	Show previous or next menu or item.
	Right arrow	menu	Show first item in the selected menu, or next menu.
		item	Change to Edit mode.
	Left arrow	menu or item	Show parent menu.
	Mode key	menu or item	Change to RUN mode.
	Home key	menu or item	Show first item of top level menu (menu 1, item 1).
		menu or item	Select appropriate item or menu ¹ .

Hand-held programmer: key functions in Edit mode

Key	Edit Mode
	Right arrow: accept the data (write the parameter) and change from Edit to Navigation mode.
	Left arrow: cancel Edit mode without changing the parameter.
	Erase the most recently changed character. If this is the first key in Edit mode, erase the display.
	Add a decimal point.
	Change the sign of the entered value.
	Add the corresponding character.

Individual Parameter Reset

1. Press **Right ARROW** , then **CLEAR** , then **Right ARROW** .
2. The value returns to the factory default.

¹ For example, press **3** to move to the third item in the current menu.

Notes:

Appendix E: HART Communications

Highway Addressable Remote Transducer, HART, is an industrial protocol that is superimposed on the 4-20 mA signal. It is an open standard, and full details about HART can be obtained from the HART Communication Foundation at www.hartcomm2.org

SITRANS LR460 can be configured over the HART network using either the HART Communicator 375 by Fisher-Rosemount, or a software package. There are a number of different software packages available. The recommended software package is the SIMATIC Process Device Manager (PDM) by Siemens.

HART Device Description (DD)

SITRANS LR460 cannot be set up using a generic DD. The configuration software needs the HART Device Description for SITRANS LR460.

You can download the HART DD for SITRANS LR460 from the product page of our website. Go to: www.siemens.com/lr460 and click on **Downloads**.

Older versions of the library will have to be updated in order to use all the features of SITRANS LR460.

SIMATIC Process Device Manager (PDM)

This software package is designed to permit easy configuration, monitoring, and troubleshooting of HART devices. The HART DD for SITRANS LR460 was written with SIMATIC PDM in mind and has been extensively tested with this software.

For more information see *SIMATIC PDM* on page 119.

HART modem interface for SIMATIC PDM

To interface SIMATIC PDM with a HART device you will need a HART modem. Two options are available.

HART Modem model	Part Number
HART modem/RS-232 (for use with a PC and SIMATIC PDM)	7MF4997-1DA
HART modem/USB (for use with a PC and SIMATIC PDM)	7MF4997-1DB

HART Version

SITRANS LR460 conforms to HART rev. 5.1.

HART Burst Mode

SITRANS LR460 does not support Burst Mode.

HART Communication Parameter



Warning: Incorrect use of this parameter can cause all communication to be lost.

To set the number of preamble requests open the menu **Device – HART Communication**.

HART Communicator 375 Menu Structure

Note: HART Communicator 375 is supported by SITRANS LR460 HART. The menu structure is aligned with the menu structure of SIMATIC PDM.

SITRANS LR460

DD-Version

Identification

Operation Unit	Tag Description Message
Device	Manufacturer Product designation Device Serial Number Order No. Date of Birth Software Revision Hardware Revision Last config Local Operation Enable Language

Input

Standard Setup	Antenna Response Rate
Sensor Calibration	Sensor Units Calibration Type Low Calibration Pt. High Calibration Pt. Unit (Level) Low Level Point High Level Point Level Offset Sensor Offset Temperature Units
Detailed Setup	
Fail-Safe	LOE Timer Restrict rate out of LOE
Echo Select	Algorithm Threshold Long Echo Marker Narrow Echo Filter Reform Echo Position Detect
Sampling	Window Shots

Output

Range	Near Range Far Range
TVT Setup	Auto False Echo Suppression Range TVT Hover Level Shaper Mode
TVT Shaper	Shaper 1-9 (Shaper Points 1-9) Shaper 10-18 (Shaper Points 10-18) Shaper 19-27 (Shaper Points 19-27) Shaper 28-36 (Shaper Points 28-36) Shaper 37-45 (Shaper Points 37-45) Shaper 46-54 (Shaper Points 46-54) Shaper 55-63 (Shaper Points 55-63) Shaper 64-72 (Shaper Points 64-72) Shaper 73-81 (Shaper Points 73-81) Shaper 82-90 (Shaper Points 82-90) Shaper 91-99 (Shaper Points 91-99) Shaper 100-108 (Shaper Points 100-108) Shaper 109-117 (Shaper Points 109-117) Shaper 118-120 (Shaper Points 118-120)
Rate	Fill Rate (/min) Empty Rate (/min)

Analog Input Function Block 1	
Unit	
Filter Time Const	
Function	
Process Value Scale	Lower Value Upper Value
Output scale	Lower Value Upper Value
Output Limits	Lower Limit Alarm Upper Limit Alarm Limit Hysteresis
Human Interface	
	Decimal Point Out unit text
Analog Input Function Block 2	
Unit	
Filter Time Const	
Function	
Process Value Scale	Lower Value Upper Value
Output scale	Lower Value Upper Value

	Output Limits	Lower Limit Alarm Upper Limit Alarm Limit Hysteresis
	Human Interface	Decimal Point Out unit text
mA Output		mA Allocation mA min Limit mA max limit Failsafe Mode Failsafe Value
Relay Configuration		Relay AIFB Relay Function Relay NO/NC Relay State

Device Certification

Maintenance Settings

Remaining Device Lifetime	Total Device Operating Time Remaining Lifetime Maintenance Required Limit Maintenance Demanded Limit Maintenance Alert Activation Total Expected Device Life
Remaining Sensor Lifetime	Total Sensor Operating Time Remaining Sensor Lifetime Maintenance Required Limit Maintenance Demanded Limit Maintenance Alert Activation Total Expected Sensor Life
Service Interval	Time Lapsed Since Last Service Maintenance Required Limit Maintenance Demanded Limit Maintenance Alert Activation Total Service Interval
Calibration Interval	Time Lapsed Since Last Calibration Maintenance Required Limit Maintenance Demanded Limit Maintenance Alert Activation Total Calibration Interval

Notes:

Appendix F: HART Information Structure

SITRANS LR460 detects a material level via the sensor, and then processes that information to provide a measured value. The measured value is conveyed as a digital signal.

The LR460 device design enables it to provide outputs to two different channels:

- a 4-20 mA channel
- a digital channel

Block Model for recording and processing measured values

The LR460 follows a profile block model similar to a PROFIBUS Profile 3.01, Class B, PA device. The functions of the device are divided into blocks.

Information is recorded by the sensor, then passed through the Level Transducer Block to two independent Analog Input Function Blocks (AIFB1 and AIFB2).

The parameters used to configure the Function Blocks are standard profile parameters, following a convention similar to that used in the PROFIBUS Profile Structure. They can be modified by HART communications via PDM.

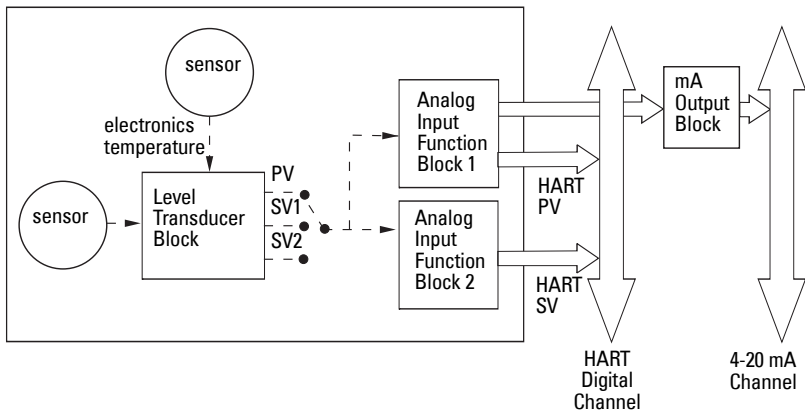

Level Transducer Block (LTB)

The Level Transducer Block carries out adjustments to the sensor, such as level calibration. It supplies the output (Primary Value/PV, or Secondary Value 1/SV1, or Secondary Value 2/SV2) which is utilized by either or both of the AIFBs.

Analog Input Function Blocks AIFB1 and AIFB2

The two AIFBs are identical, but completely independent of each other. They utilize the output from the Level Transducer Block.

You set parameters for each AIFB in order for it to apply any required quality checks, scaling, and Fail-safe Operation selections.

AIFB1

The output of Analog Input Function Block 1 supplies the measured value and associated status information as a digital signal to two communication channels:

- via the mA Output Block to a 4 to 20 mA channel
- to the HART digital channel, as the HART Primary Variable. This can only be viewed via the HART digital channel.

AIFB2

The output of Analog Input Function Block 2 supplies the measured value and associated status information as a digital signal to the HART digital channel, as the HART Secondary Variable. This can only be viewed via the HART digital channel.

Description of the blocks

For a detailed description of how the Level Transducer Block and Analog Input Function Blocks process information, see *Description of the blocks* on page 132.

Appendix G: Communications via PROFIBUS PA

SITRANS LR460 is a Profile Version 3.01, Class B, PA device. It supports Class 1 Master for cyclic and acyclic data exchange, and Class 2 for acyclic services. The full range of SITRANS LR460 functions is available only over a PROFIBUS PA network.

PROFIBUS PA is an open industrial protocol. Full details about PROFIBUS PA can be obtained from PROFIBUS International at www.profibus.com.

Device Configuration tool

To use PROFIBUS PA, you will need a PC configuration tool: we recommend SIMATIC PDM. Please consult the operating instructions or online help for details on using SIMATIC PDM. (You can find more information at <https://pcs.khe.siemens.com/index.aspx?nr=3695>.)

SIMATIC PDM

SIMATIC PDM is a software package used to commission and maintain SITRANS LR460 and other process devices. For more detail see *Operating SITRANS LR460 via SIMATIC PDM* on page 37.

Device Description

In order to use **Process Device Manager (PDM)** with PROFIBUS PA, you will need the Device Description for SITRANS LR460. For details see *Device Description (DD)* and *Configuring a new device* on page 31 to configure your device and load the newest version of the Device Description (DD).

Network Configuration

To configure a PROFIBUS Class 1 Master (for example, a PLC), you will need a **GSD** file.

The GSD file

The GSD file **SIEM8132.gsd** is available from the SITRANS LR460 product page on our web site. Go to www.siemens.com/lr460 and click **Downloads**.

Bus Termination

Note: PROFIBUS PA MUST be terminated at both extreme ends of the cable for it to work properly. Please refer to the PROFIBUS PA User and Installation Guidelines (order number 2.092), available from www.profibus.com.

Power Demands

To determine how many devices can be connected to a bus line, calculate the combined maximum current consumption of all the connected devices: 10.5 mA for SITRANS LR460. Allow a current reserve for safety.

PROFIBUS address

A unique PROFIBUS address identifies each device on the network. To set the PROFIBUS address see *2.1.2. Address (ADDR) on page 49*.

Notes:

- It is possible to change the device address via a class 1 master (for example, a PLC), and lock the device address to prevent further changes.
- If this Address Lock is on, the PA address cannot be changed. This lock can be disabled only by performing an Address Reset.

Resetting the PROFIBUS address to 126:

- Via SIMATIC PDM:
 - a. Open the menu **Device - Device Reset**
 - b. Select the option **Address Reset**. The address is reset to 126 and the address lock is disabled.
- Via the handheld programmer:
 - a. Navigate to **Identification (2.) > Configuration (2.1) > Reset (2.1.4)**.
 - b. Press **RIGHT Arrow** to open Edit Mode and **DOWN Arrow** to scroll down to select **Reset Device**. The address will be reset to 126. If the address lock was on, it will be disabled.

Operating as a Profile Device

Every manufactured PROFIBUS product has a unique PROFIBUS identification number which identifies it to the system. PROFIBUS Profile Standard version 3.01 also defines a Profile Model which can identify a product as a generic profile device on the network.

SITRANS LR460 can be identified in one of three ways:

Device Identification	Profile Model
SITRANS LR460	Manufacturer-specific [uses Siemens DD and GSD file, which identifies the LR460 (PROFIBUS PA)].
1 Analog Input Function Block Device	Profile-specific [uses generic GSD for 1 AIFB (ident # = 0x9700)]
2 Analog Input Function Block Device	Profile-specific (uses generic device DD and profile GSD for class B device)

Defining the device as Profile-specific as opposed to Manufacturer-specific makes it possible to exchange the device for any other device of the same profile type without changing the GSD file.

To set up SITRANS LR460 as a profile device see *2.2.3. PROFIBUS Ident Number (IDENT NUM) (PROFIBUS PA only) on page 54*.

Configuring a new device: procedure

See *Configuring a new device* on page 41.

Configuring PROFIBUS PA with an S7-300/ 400 PLC

1. If SITRANS LR460 is not listed in the STEP 7 device catalog, you can download the GSD file from our website and install it in STEP 7. Go to: www.siemens.com/lr460 and click **Downloads**.
2. Add the SITRANS LR460 "rack": click and drag the SITRANS LR460 folder from the hardware catalog.
3. Fill the rack with desired modules, by dragging and dropping them from the hardware catalog.
4. After configuring PROFIBUS PA in steps 2 and 3, download it to the PLC.
5. Add code to the PLC program to read data consistently using the SFC14.

Cyclic versus Acyclic Data

When you request data from a device via PROFIBUS PA, you have two choices. Cyclic data is provided at every bus scan; acyclic data is requested and provided as needed.

Input information is always requested at every bus scan and is set up as cyclic data. Configuration information is only needed periodically and is set up as acyclic data.

Cyclic Data

When you configure SITRANS LR460 on the PROFIBUS PA bus, there are two slots available for modules.

Note: Each of the slots has to have a module defined in it.

Slot 0 always transmits **AIFB1** information¹; slot 1 defaults to Free Place, but can be changed to **AIFB2** information. If you do not wish to have data transmitted, then you must use a **Free Place** module in that slot.

Each of the two Analog Input Function Blocks can be set up to return **Level**, or **Distance**. Within the function blocks, the values are scaled according to the user requirements (see *Analog Input Function Blocks 1 and 2* on page 134 for details).

¹ See *Analog Input Function Blocks 1 and 2* on page 134 for more information.

AIFB1 and **AIFB2** return 5 bytes of data each:

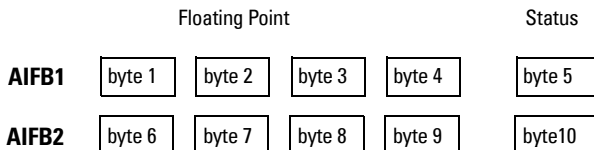

The first 4 bytes are the floating point representation (IEEE) of the variable. The variables are the outputs of the function block. The 5th byte is the status word and the list of possible values is given in the chart below.

The 5 bytes must be read consistently, in a contiguous chunk: they cannot be read byte by byte, and cannot suffer an interrupt. If you are using an S7-300 / 400, you will need to use SFC14 DPRD_DAT: Read Consistent Data of a Standard PD Slave.

Status Byte

In PROFIBUS PA there are two possible types of status byte:

- **status byte:** originally defined in Profile Standard V3.0
- **condensed status:** an alternative status byte defined in Profile Standard V3.01

You can choose which type of status byte will be returned, by enabling or disabling *Z1. Condensed Status Mode (COND STAT)* on page 88. The default setting is Condensed Status disabled: Status Byte will be returned, and the following codes will be used.

Status Codes for Good Quality	
Values in hex notation	Description
0x80	Data is GOOD.
0x84	A parameter in the function block has been changed: status active for 10 s
0x89	Active low warning.
0x8A	Active high warning.
0x8D	Active low alarm.
0x8E	Active high alarm.
Status Codes for Uncertain Quality	
Values in hex notation	Description (cont'd)
0x4B	Value is a substituted value (normally used in Fail-safe).
0x4C/0x4F	Initial value.
0x47	Last usable value.

Status Codes for Bad Quality

Values in hex notation	Description
0x10	The LOE timer has expired: this could be caused by LOE or by a sensor malfunction: value is BAD.
0x01	There is an error in the configuration of the function blocks in PROFIBUS PA ^a .
0X1F	The function block, or the transducer block, has been placed out of service.
0xC4	Bad configuration: value is BAD.
0XDE	All block out of service: value is BAD.

- ^a. This could happen when a firmware download has been done, but a system reset has not been done. This could also happen if the function blocks are not configured properly using the handheld programmer, PDM or acyclic services.

Condensed Status

These codes are available when Condensed Status is enabled. See *7. Condensed Status Setup (COND SETUP) (PROFIBUS PA only)* on page 88. for more details.

Condensed Status Codes for Good Quality		
Hex value	Status – GOOD	Description
0x80	GOOD – ok	No error or special condition is associated with this value.
0x84	GOOD – update event	Set if the value is good and the block has an active Update event. (This status remains active for 20 seconds.)
0x86	GOOD – active advisory alarm	Set if the value is good and the block has an active Alarm.
0x80 ...0x8E	GOOD – limit check/ update event	See <i>Status Codes for Good Quality</i> on page 122 .
0xA0 ...0xA3	GOOD – initiate fail safe	This fault is not generated by the product, but can be simulated.
0xA4 ...0xA7	GOOD – maintenance required	Value is valid. Maintenance is recommended within a medium-term period.
0xA8 ...0xAB	GOOD – maintenance demanded	Value is valid. Maintenance is demanded within a short-term period.
0xBC ...0xBF	GOOD – function check	Device performs internal function check without influencing the process. Value is valid.

Condensed Status Codes for Uncertain Quality		
Hex value	Status – UNCERTAIN	Description
0x45	UNCERTAIN – substitute set	Output of Failsafe logic only.
0x4F	UNCERTAIN – initial value	Default value as long as no measured value is available or until a diagnosis is made that affects the value and the status accorded to it.
0x68 ...0x6B	UNCERTAIN – maintenance demanded	Usability of the process value depends on the application. Value is potentially invalid. Cause is a wear ^a detected in the device. Maintenance is demanded within a short-term period.

Condensed Status Codes for Uncertain Quality (cont'd)		
Hex value	Status – UNCERTAIN	Description (cont'd)
0x73	UNCERTAIN – simulated value, start	<p>Indicates the start of a simulation. Simulation of a measured value or Input FB mode changes from AUTO to MAN.</p> <ul style="list-style-type: none"> This status remains active for at least 10 seconds: <ul style="list-style-type: none"> – after enabling simulation – after setting the FB to MAN mode – after a restart (e.g. power down cycle) if the simulation is enabled or the FB is in MAN mode – after passivation is cleared if simulation is enabled or the FB is in MAN mode In MAN mode the status remains until a subsequent write command overwrites the OUT value after the 10 seconds have expired. In simulation mode the written status is buffered and appears in the value flow after 10 seconds. However the new written SIMULATE parameter with its status can be read before the 10 seconds have expired.
0x74 ...0x77	UNCERTAIN – simulated value, end	<p>Indicates the end of a simulation. Simulation of a measured value is disabled or Input FB mode changes from MAN to AUTO.</p> <p>This Status remains active for 10 seconds after simulation ends.</p> <p>While this status is active there is no reliable process value. Measured values and their status are updated afterwards.</p>

a. See *Wear* on page 141 for more detail.

Condensed Status Codes for Bad Quality		
Hex value	Status BAD	Description
0x00	BAD – non specific	Proxy determines that a device does not communicate.
0x23	BAD – passivated (diagnostics alerts disabled)	Configured failsafe value is used, accompanied by this status.
0x24 ...0x27	BAD – maintenance alarm, more diagnosis available	No measurement available because of a failure.
0x25	BAD – process related, no maintenance	No measurement available because of invalid process conditions.
0x3C ...0x3F	BAD – function check / local override, value not usable	Occurs during cleaning or calibration process.

Diagnostics

All diagnostic information shown below is viewable via PDM.

Diagnosis reply (applies only to cyclic masters)

During DPV0 data exchange, the PROFIBUS PA slave will notify the Master when a serious error occurs. The Master will then send a Diagnosis request. The reply to this request is normally logged in the PLC and is referred to as the "Hex values."

The reply may contain two parts. The first part is 6 bytes long and is defined by the PROFIBUS standard. If there is a second part, it is called the 'extended diagnostic' and it is eight bytes long. The last four bytes of the extended diagnostic message give the error code shown below. (The same information is also available acyclically via the Diagnosis Object.

Acyclic Diagnostics

This consists of four bytes.

In PROFIBUS PA there are two possible types of Acyclic Diagnostics:

- **Extended Mode Diagnosis**
- **Condensed Mode Diagnosis**

You can choose which of these will be returned, by enabling or disabling *7.1. Condensed Status Mode (COND STAT) on page 88*. The default setting is Condensed Status disabled: Extended Mode Diagnosis will be returned, and the following codes on page 127 will be used.

Extended Mode Diagnosis

Extended Mode Diagnosis				
Hex values	Byte	Bit	Description	Indication class ^a
0x01000000	0	0	Electronics failure	R
0x02000000		1	Mechanical failure	R
0x04000000		2	Motor Temperature too high	R
0x08000000		3	Electronics temperature too high	R
0x10000000		4	Memory error	R
0x20000000		5	Measurement failure	R
0x40000000		6	Device not initialized (no calibration)	R
0x80000000		7	Self calibration failed	R
0x00010000	1	0	Zero point error (limit position)	R
0x00020000		1	Power supply failure (electrical, pneumatic)	R
0x00040000		2	Configuration invalid	R
0x00080000		3	New startup carried out (Warm Start)	A
0x00100000		4	Restart carried out (Cold Start)	A
0x00200000		5	Maintenance required	R
0x00400000		6	Characterization invalid	R
0x00800000	7	Set to 1 (one), if the Ident_Number of the running cyclic data transfer and the value of Physical Block IDENT__NUMBER_SELECTOR parameter are different.	R	
	2	0 to 7	Reserved for use within the PNO	
	3	0 to 6	Reserved for use within the PNO	
0x00000080		7	More diagnosis information is available	

- ^a **R** indicates the message remains active as long as the reason for the message exists.
A indicates the message will automatically reset after 10 seconds

Values of the DIAGNOSIS bit:

0 = not set

1 = set

Condensed Mode Diagnosis

Condensed Mode Diagnosis				
Hex values	Byte	Bit	Description	Indication class ^a
0x00000800	2	3	New startup carried out (Warm Start)	A
0x00001000		4	Restart carried out (Cold Start)	A
0x00002000		5	Maintenance required	R
		6	Reserved for use within the PNO	
0x00008000		7	Set to 1 (one), if the Ident_Number of the running cyclic data transfer and the value of Physical Block IDENT_NUMBER_SELECTOR parameter are different.	R
0x00010000	3	0	Failure of the device or armature	R
0x00020000		1	Maintenance demanded	R
0x00040000		2	Device is in function check mode, or simulation, or under local control e.g. maintenance	R
0x00080000		3	The process conditions do not allow the return of valid values. (Set if a value has the quality Uncertain - Process related, no maintenance or Bad - Process related, no maintenance.)	R
		4 to 7	Reserved for use within the PNO	
	4	0 to 6	Reserved for use within the PNO	
0x80000000		7	0: There is no more information available 1: More diagnosis information is available in DIAGNOSIS_EXTENSION	

- ^a **R** indicates the message remains active as long as the reason for the message exists.
A indicates the message will automatically reset after 10 seconds

Acyclic Extended Diagnostics (General Fault Codes)

In addition to the extended diagnostics available by cyclic data exchange (shown above), further extended diagnostics are available via acyclic communications. This consists of six bytes. See *Acyclic Data* on page 129 for information on the location of **Extended Diagnostics**.

For a table listing the fault codes, meanings, and suggested corrective action to take, see *General Fault Codes* on page 102.

Acyclic Data

SITRANS LR460 supports up to four simultaneous connections by a Class 2 Master (C2 connection). It supports one connection by a Class 1 Master (C1 connection).

In order for a Class 1 Master to read parameters from an instrument, it needs to know the slot and absolute index of the parameter.

The parameters are all listed in SIMATIC PDM under Help. If you do not have SIMATIC PDM you can download the DD and reference the HTML help file directly.

To find the slot and index numbers via SIMATIC PDM, go to **Help > Communications**, and select the appropriate block from the list. For each parameter, the slot and the relative index is listed. For example:

AIFB 1		
Index	Parameter	Datatype
1	Static Revision No.	UNSIGNED_INTEGER (2)

Each block has a slot number and an Index Offset value.

Block Name	Slot	Index Offset
Physical block	0	16
Transducer block	0	77
AIFB 1	1	16
AIFB 2	2	16

To get the the absolute index for any parameter , add the Index Offset for the appropriate block to the relative index for that parameter. The parameter takes the slot number of the block in which it is located.

For example:

- Parameter **Static Revision Number** has relative index = 1 and is located on AIFB1.
- It has Absolute Index = 17 (relative index 1 + index offset 16).
- It is located at Slot 1 (the slot number for AIFB 1).

Notes:

Appendix H: PROFIBUS PA Profile Structure

PROFIBUS Level Device Design

The device follows the profile block model and is implemented as a Profile 3.01, Class B, PA device. Standard profile parameters are used to program the Level Transducer Block.

Block Model for recording and processing measured values

The functions of the device are divided into blocks for different areas of responsibility. They can be parameterized by acyclic data transfer via PDM.

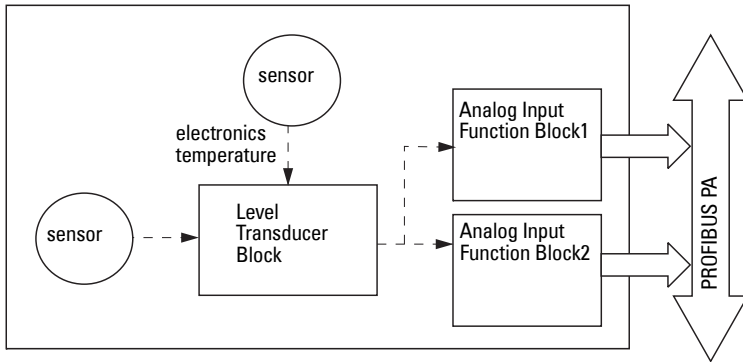

The device is implemented with one Level Transducer Block (LTB), and two Analog Input Function Blocks (AIFB1 and AIFB2).

All data is viewed from the perspective of the DCS or PLC, so information from the sensor is an input.

Level Transducer Block (LTB)

The Level Transducer Block (LTB) carries out adjustments to the sensor, such as level calibration. It supplies the outputs utilized by either or both of the AIFBs.

Analog Input Function Blocks AIFB 1 and AIFB 2

The two AIFBs are completely independent of each other. They utilize the output from the TB, and apply any required quality checks, scaling, and Fail-safe operation selections.

The output of an Analog Input Function Block supplies the measured value and associated status information to PROFIBUS PA, via cyclic data transfer.

Description of the blocks

Level Transducer Block function groups

Note: Primary Value (PV) is the default measured value; Secondary Value 1 (SV1) is an equivalent value.

The figure below shows the signal flow of measured values from the sensor through the Level Transducer Block into the output value (Primary Value/ Level; Secondary Value 1 / Level; or Secondary Value 2 /Distance). The LTB implements all of the basic parameters (see parameter diagram on page 133).¹

Level Transducer Block

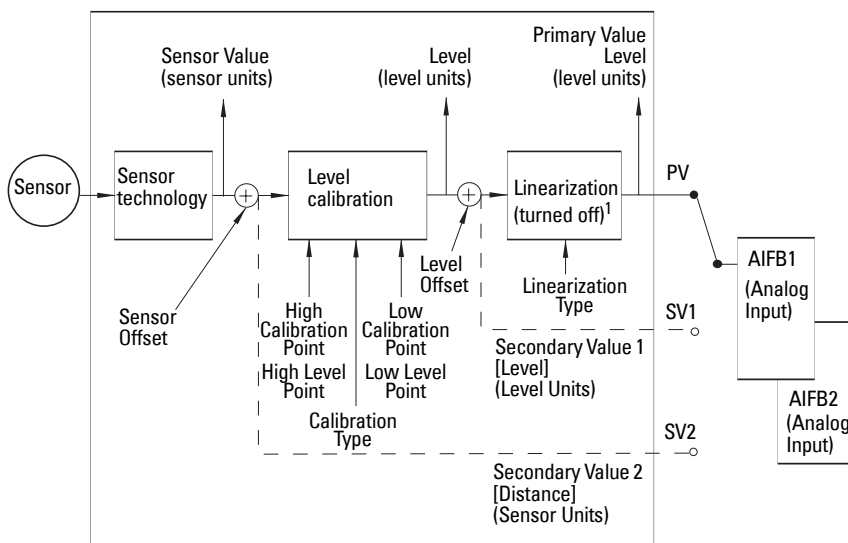

How the Level Transducer Block works:

1. The sensor technology block selects the proper echo. See *Echo selection* on page 92 for more detail.

The sensor value (in sensor units) is checked to see if it is within its measuring limits. If the limit is exceeded, this results in a **Bad** status and the error message **Failure in measurement**. The sensor value is stored in Sensor Value.

The analog signal from the sensor is transformed into a digital signal.

A Sensor Offset (default 0) provides compensation if necessary for differences between the vessel reference point and the sensor reference point.

¹ A Linearization module is required by the PROFIBUS PA specifications. The Linearization block is turned off in SITRANS LR460.

- Level Calibration is a linear transfer function that converts a sensor value to a level value.

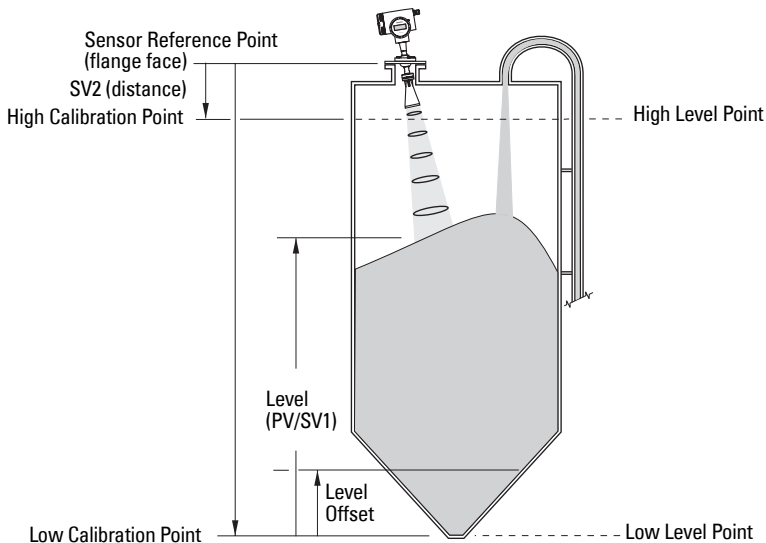
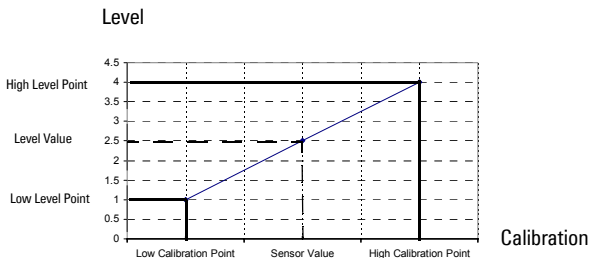

- The Level Transducer Block (LTB) provides three possible outputs
 - Primary Value (PV)/Level
 - Secondary Value 1 (SV1)/Level (plus level offset, if any)
 - Secondary Value 2 (SV2)/Distance (in Sensor units)

Electronics temperature

The Level Transducer Block also monitors the internal temperature of the device electronics. If the temperature exceeds permitted limits, it does not change the sensor value, but it does change the status. The permitted limits correspond to those of the permitted ambient temperature.

If a temperature limit is exceeded, the status changes. Peak indicators¹ allow you to check the maximum and minimum temperatures that have occurred.

Analog Input Function Blocks 1 and 2

There are two identical Analog Input Function Blocks which operate independently. The figure below shows how measured values are processed within the Analog Input Function Block (AIFB 1 or AIFB 2) to produce the device output, which is communicated via cyclic transfer to PROFIBUS PA, and displayed on the LCD.

Analog Input Function Block function groups (simulation, mode and status)

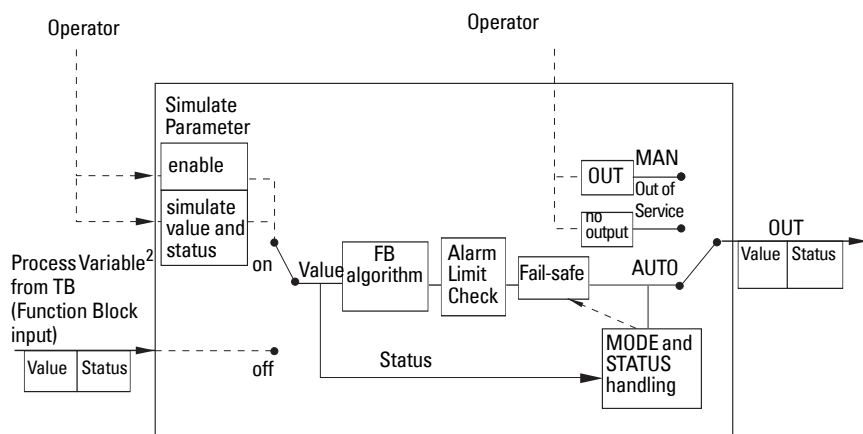

How the AIFBs work

The Analog Input Function Blocks allow you to control modifications to the output value (PROFIBUS cyclic data).

1. Open View menu, scroll down to Peak Values, and click on Temperature tab in the Peak Values window.
2. The output from the Level Transducer Block can be called the Primary Value (or Secondary Value). When it becomes the input to the AIFB, it is called the Process Variable.

Output Conversion

Values transmitted by the TB have a status attached. The decision on what to do with each value is made by the Analog Input Function Block.

Device/ Input Simulation

The input can be a simulated value instead of a TB OUT value. This allows the AI block to be tested independently of the characteristics of the environment.

Fail-safe

- If the status of the Primary Value or Simulation Value is **bad**, the fault logic can output either the last usable measured value, or a given substitute value.

Device / Output Simulation

One of three settings can be selected. The result is the output parameter (OUT).

Setting	description	Output value
AUTO	automatic	the automatically-recorded measured value
MAN	manual	a manually-set fixed simulation value
OS	function block disabled	the preset safety value.

AIFB execution steps:

The AIFBs can provide a linear conversion to any desired units.

1. A linear transfer function converts a TB value to an Output Value. (This step is performed within the FB Algorithm block: see the diagram on page 134.)

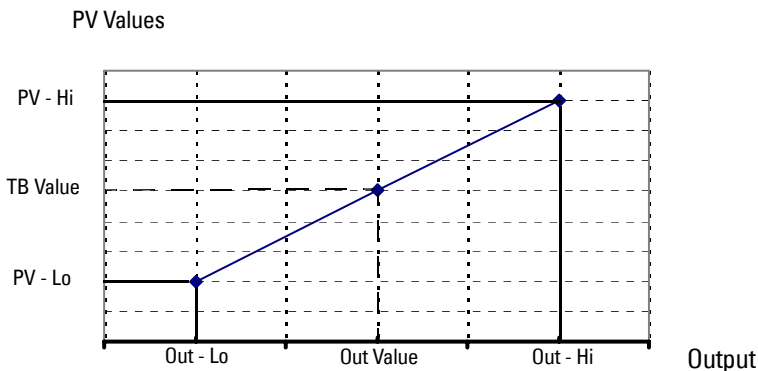

2. This value is filtered using a first order filter based on a time constant provided by the user.
3. The value is checked against the user parameterized warning and alarm limits. (There is an upper and lower warning limit and an upper and lower alarm limit.)

The unit of the limits corresponds to the unit of the output range. A hysteresis parameter prevents toggling in the Status field of the OUT value.)

4. The status of the Process Variable (input value) is checked. If the status is Bad, a Fail-safe condition occurs. The output is determined by the Fail-safe Mode of the block.
5. The target mode parameter allows the entire AI block to be overridden by a Manual Out value.
6. The OUT VALUE parameter is the value for the cyclic data transfer.

Appendix J: Software Revision History

Note: The software revision number of the device is shown on the sticker on the product.

PROFIBUS PA

Software Rev.	DD Rev.	Date	Changes
1.04.02	1.04.04	Jun. 29, 2007	<ul style="list-style-type: none">Initial release.
1.04.04	1.04.04	Apr. 16, 2008	<ul style="list-style-type: none">No longer reports an incorrect diagnostic in the measurement process.
1.05.03	1.05.03	May 28, 2008	<ul style="list-style-type: none">Updated I & M call functions.Improved DD user interface.Supports PDM 5.2.

J: Software Rev.

HART

Software Rev.	DD Rev.	Date	Changes
1.03.00-00	1.03.01-00	Jan. 12, 2007	<ul style="list-style-type: none">Initial release.
1.04.02	1.04.05	Jun. 29, 2007	<ul style="list-style-type: none">New mA/HART hardware.
1.04.04	1.04.05	Apr. 16, 2008	<ul style="list-style-type: none">No longer reports an incorrect diagnostic in the measurement process.
1.05.03	1.05.03	May 28, 2008	<ul style="list-style-type: none">Improved DD user interface.Supports PDM 5.2.

Notes

Glossary

accuracy: degree of conformity of a measure to a standard or a true value.

agitator: mechanical apparatus for mixing or aerating. A device for creating turbulence.

algorithm: a prescribed set of well-defined rules or processes for the solution of a problem in a finite number of steps.

ambient temperature: the temperature of the surrounding air that comes in contact with the enclosure of the device.

antenna: an aerial which sends out and receives a signal in a specific direction. There are four basic types of antenna in radar level measurement, horn, parabolic, rod, and waveguide.

attenuation: a term used to denote a decrease in signal magnitude in transmission from one point to another. Attenuation may be expressed as a scalar ratio of the input magnitude to the output magnitude or in decibels.

Auto False-Echo Suppression: a technique used to adjust the level of a TVT curve to avoid the reading of false echoes. (See TVT.)

Auto False-Echo Suppression Distance: defines the endpoint of the TVT distance. (See TVT.) This is used in conjunction with auto false echo suppression.

beam angle: the angle diametrically subtended by the one-half power limits (-3 dB) of the sound beam.

beam spreading: the divergence of a beam as it travels through a medium.

blanking: see Near Range.

capacitance: the property of a system of conductors and dielectrics that permits the storage of electricity when potential differences exist between the conductors. Its value is expressed as the ratio of a quantity of electricity to a potential difference, and the unit is a Farad.

confidence: describes the quality of an echo. Higher values represent higher quality. Confidence threshold defines the minimum value.

damping: term applied to the performance of an instrument to denote the manner in which the measurement settles to its steady indication after a change in the value of the level.

dB (decibel): a unit used to measure the amplitude of signals.

derating: to decrease a rating suitable for normal conditions according to guidelines specified for different conditions.

dielectric: a nonconductor of direct electric current.¹

dielectric constant (DK): the ability of a dielectric to store electrical potential energy under the influence of an electric field. Also known as Relative Permittivity. An increase in the dielectric constant is directly proportional to an increase in signal amplitude. The value is usually given relative to a vacuum /dry air: the dielectric constant of air is 1¹.

echo: a signal that has been reflected with sufficient magnitude and delay to be perceived in some manner as a signal distinct from that directly transmitted. Echoes are frequently measured in decibels relative to the directly transmitted signal.

echo confidence: the recognition of the validity of the echo. A measure of echo reliability.

Echo Marker: a marker that points to the processed echo.

Echo Processing: the process by which the radar unit determines echoes.

Echo Strength: describes the strength of the selected echo in dB above 1 μ V rms.

Echo Profile: a graphical display of a processed echo.

emission cone: the extension of the antenna's angle

false echo: any echo which is not the echo from the desired target. Generally, false echoes are created by vessel obstructions.

frequency: the number of periods occurring per unit time. Frequency may be stated in cycles per second.

hertz (Hz): unit of frequency, one cycle per second. 1 Gigahertz (GHz) is equal to 10^9 Hz.

horn antenna: a conical, horn-shaped antenna which focuses microwave signals. The larger the horn diameter, the more focused the radar beam.

inductance: the property of an electric circuit by virtue of which a varying current induces an electromotive force in that circuit or in a neighboring circuit. The unit is a Henry.

microwaves: the term for the electromagnetic frequencies occupying the portion of the radio frequency spectrum from 1 GHz to 300 GHz.

multiple echoes: secondary echoes that appear as double, triple, or quadruple echoes in the distance from the target echo.

Near Range: a blind zone extending away from the reference point plus any additional shield length. The instrument is programmed to ignore this zone.

nozzle: a length of pipe mounted onto a vessel that supports the flange.

parameters: in programming, variables that are given constant values for specific purposes or processes.

polarization: the property of a radiated electromagnetic wave describing the time-varying direction and amplitude of the electric field vector.

1. Many conductive liquids/electrolytes exhibit dielectric properties; the relative dielectric constant of water is 80.

polarization error: the error arising from the transmission or reception of an electromagnetic wave having a polarization other than that intended for the system.

PROFIBUS PA: part of the PROFIBUS protocol that is specifically tailored for the needs of process industries (PA = Process Automation).

propagation factor (pf): where the maximum velocity is 1.0, pf is a value that represents a reduction in propagation velocity as a result of the wave travelling through a pipe or medium.

pulse radar: a radar type that directly measures distance using short microwave pulses. Distance is determined by the return transmit time.

radar: radar is an acronym for **RA**dio **D**etection **A**nd **R**anging. A device that radiates electromagnetic waves and utilizes the reflection of such waves from distant objects to determine their existence or position.

range: distance between a transmitter and a target.

range extension: the distance below the zero percent or empty point in a vessel.

relative permittivity: see dielectric constant.

repeatability: the closeness of agreement among repeated measurements of the same variable under the same conditions.

shot: one transmit pulse or measurement.

speed of light: the speed of electromagnetic waves (including microwave and light in free space. Light speed is a constant 299,792,458 meters per second.

stillpipe: a pipe that is mounted inside a vessel parallel to the vessel wall, and is open to the vessel at the bottom.

stilling-well: see **stillpipe**.

two wire radar: a low-energy radar. Can be loop powered, analog, intrinsically safe, or a digital (BUS) transmitter.

TVT (time varying threshold): a time-varying curve that determines the threshold level above which echoes are determined to be valid.

waveguide antenna: a hollow, metallic tube that transmits a microwave signal to the product target.

wear: difference between a current measurement and the benchmark value separating the startpoint and endpoint of, for example, device lifetime. If the current value is less than the benchmark, it indicates a 'wear'. This does not have to be measured in time: it could be, for example, the percentage loss of a protective coating.

Notes

Index

A

- abbreviations
 - list 4
- accuracy
 - specifications 7
- activating LR460 27
- address 49, 51
- application example 36
- approvals 11
- Auto False-Echo Suppression
 - explanation 93
 - TVT shaper adjustment 39
- auxiliary region
 - PROGRAM mode 107

B

- blinking
 - explanation (see Near Range) 94
 - setting (see Near Range) 62
- burst mode 112
- bus address (device address)
 - PROFIBUS PA 120
- bus termination
 - PROFIBUS PA installations 23

C

- cleaning
 - instructions 105
- communication 10
- confidence key 108
- configuration
 - PROFIBUS PA device 119
- configuring new device
 - via PDM 41, 121
- connecting HART 22
- connecting PROFIBUS PA 24
- cyclic data 121
 - versus acyclic 121

D

- device description
 - HART 111
- Device Description (DD)
 - how to update 41
- device description (DD)
 - PROFIBUS PA 119
- diagnostics 124
- dimensions 12

E

- echo confidence
 - explanation 94
- echo monitoring
 - level trend diagram 38
 - profile saving 38
- echo status indicator
 - reliable echo 107
 - unreliable echo 107

F

- factory reset
 - performing 49, 51
 - via PDM 41
- fail-safe mode
 - explanation 94
- false echoes
 - explanation 93
 - set TVT curve to ignore 93
- fault codes 102
- function keys
 - edit mode 109
 - navigation mode 109

G

- general fault codes 102
- GSD file
 - downloading 119

H

- hand-held programmer
 - parameter reset 109
 - programming 107
- HART
 - device description 111
- HART Communications
 - details 111
- HART modem 111
- HART version 112
- hazardous area installations
 - wiring requirements 25

I

- identifications and abbreviations
 - list 4
- installation
 - hazardous area requirements 25
 - requirements 13

L

- Level application example 36
- LOE timer
 - explanation 94

M

- maintenance

cleaning 105
maintenance settings 77
measure key 108
measurement response
 explanation 91
mounting
 location 13

N

Near Range
 explanation 94
 setting 62
network address 120

O

operating principles 91

P

parameter reset
 factory reset via PDM 41
 via handheld programmer 49, 51

PDM

 see SIMATIC PDM 37

power consumption 120
 PROFIBUS PA 23
primary region
 PROGRAM mode 107
 RUN mode 107

Primary Value
 relation to Process Variable 134

Primary Value (PV)
 view 68

process temperature
 maximum 96

Process Variable
 definition 68
 diagram 134

PROFIBUS address
 setting 120

PROFIBUS/HART address 49, 51
program mode icon 107
Programming SITRANS LR460 28

Q

Quick Start Wizard
 via handheld programmer 29
 via SIMATIC PDM 31

R

Range
 Far Range (range extension) 62
 Near Range (blanking) 62
Reform Echo 61
reliable echo indicator 107
repair

cautions 105
excluded liability 105
reset parameters
 factory reset 49, 51
 individual via handheld programmer
 109
 via PDM 41

RUN mode display 27

S

safety marking symbols 1
safety notes 1
Secondary Value(SV)
 view 68

SIMATIC PDM

 6.0 features 37
 overview 37, 119

SITRANS LR460
 overview 6

specifications

 accuracy 7
 approvals 11
 communication 10
 performance 7
 power 7

status byte
 status codes 122
status codes 122

T

temperature key 108
Trend Diagram
 level over time 38
TVT curve 93
 manual TVT shaper 39
TVT Shaper
 manual adjustment via PDM 39

U

unreliable echo indicator 107

W

wiring
 HART 22
 PROFIBUS PA 23

LCD menu structure

LCD menu structure

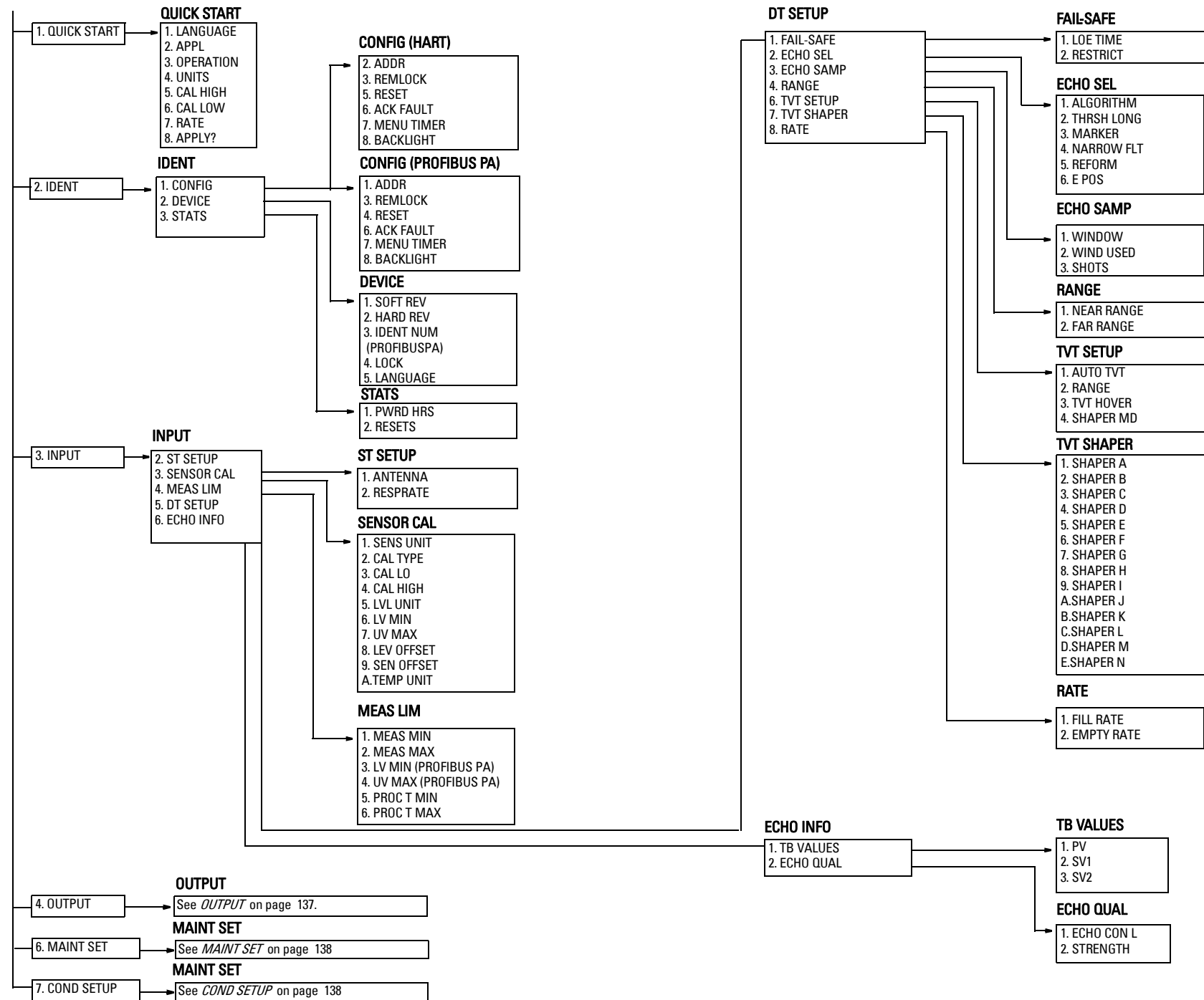

LCD menu charts (continued)

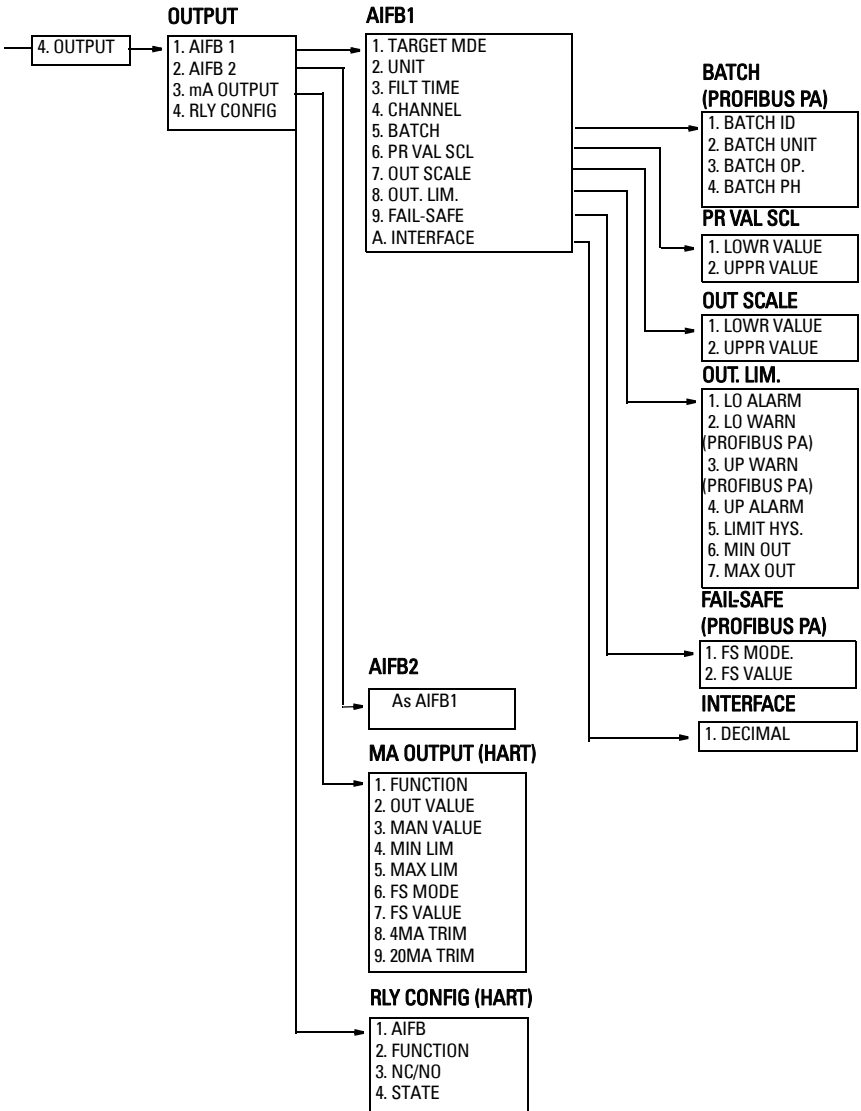

LCD menu charts (continued)

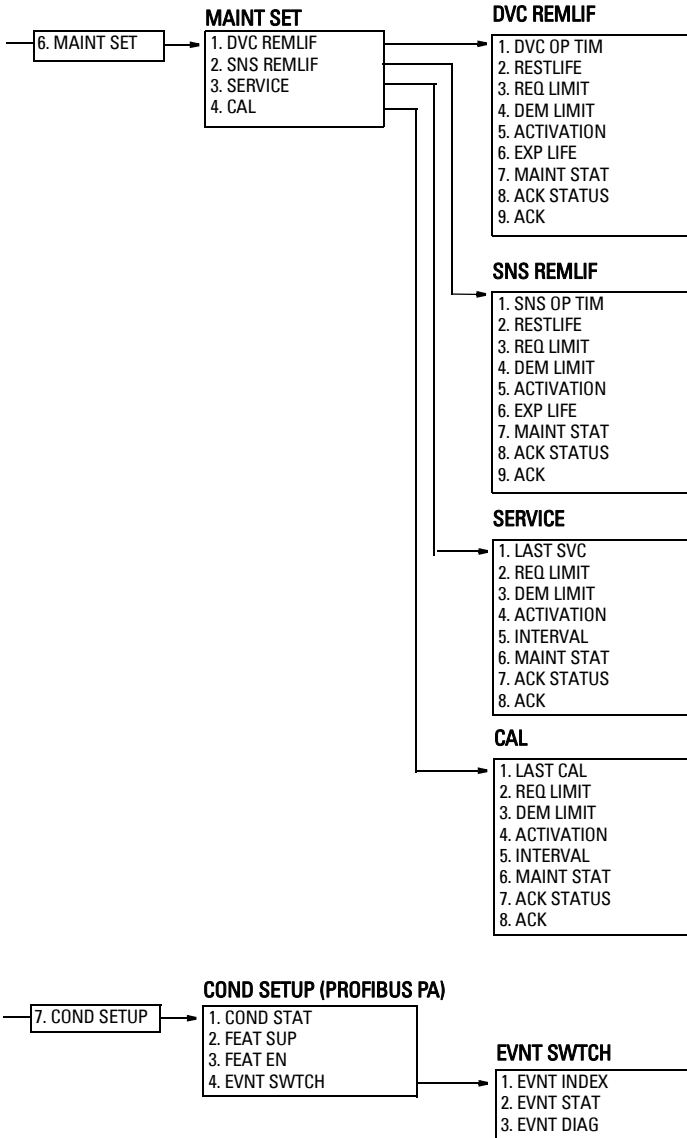



www.siemens.com/processautomation

Siemens Milltronics Process Instruments Inc.
1954 Technology Drive, P.O. Box 4225
Peterborough, ON, Canada K9J 7B1
Tel: (705) 745-2431 Fax: (705) 741-0466
Email: techpubs.smpi@siemens.com

© Siemens Milltronics Process Instruments Inc. 2008
Subject to change without prior notice



Printed in Canada

Rev. 2.1